

VKMUNV018RD930A



VividHorse UNV CCT Selectable DC Engine Retrofit Kit with 0-10V Dimming

- Universal Voltage (120~277) DC Engine
- CCT Selectable: 2700K, 3000K, 3500K, 4000K, 4500K, 5000K
- CRI90 standard
- Potassium Fluorosilicate (PFS) phosphor LEDs to achieve as high efficacy as today's CRI80 LEDs
- Suitable for open or fully enclosed luminaires
- Suitable for luminaires with plastic and glass lenses
- cULus Classified 1598C
- cULus Recognized 8750
- Energy Star Luminaire 2.2 Listed and CSD^①

General Specifications

Input Voltage ^②	120~277VAC (+/- 10%)
Input Current ^②	~0.172A @120V ~0.078A @277V
Input Power ^②	21W
Input PF	>0.98
THD	<20%
Input Frequency	50/60Hz
Module Operating Voltage	23.1VDC
Max Lumen Output @ Full Power ^②	2650 lumens @ 4000K/90CRI
Dimming Type/Range	0-10V / 100% ~ 10%
Beam Angle	120°
Color Rendering Index	CRI (Ra) >=90 / R9 >=50 / TM-30 R _a >=85 / TM-30 R _f >=100
Storage Temperature Range	-35°C to 100°C / -31°F to 212°F
Operating Ambient Temperature Range (Ta)	-35°C to 60°C / -31°F to 140°F
Maximum Driver Case Temperature: per UL/ 5 year warranty	85°C (185°F) / 76°C (168.8°F)
Maximum Module Case Temperature	Safety: 105°C(221°F)/ L70(>60Khrs): 105°C(221°F)/ L90(36Khrs): 96°C(204.8°F)
Estimated Lumen Maintenance	L70= >60,000 hours @ Tc max 105°C / L90= 36,000 hours @ Tc max 96°C
Color Consistency	Binning per ANSI C78.377-2015 @25°C; Typ. 3 SDCM, Max. 5 SDCM
Inrush Current / Duration	20A @ 277V / 250us
Line Regulation / Load Regulation	<1% @100% Load / <3% @100% Load
Total Overall Ripple LF (<300Hz)/ HF(<40kHz) peak to peak	<5% @100% Load
Low Frequency Ripple (120Hz ripple peak to peak)	<5% @100% Load
Flicker Percentage	<7% @100% - 20% Dimming Range <5% @<20% Dimming Range
Flicker P _{st} / SVM @ Min. Dimming Level per NEMA 77-2017	P _{st} : 2.602 SVM: 0.686
Start-up Time / Standby Power	<500ms / <0.5W No Load
Overall Size	7.83" Dia. x 1.18"H (199mm Dia. x 29.89mm H)
Wire Type/ Length	18AWG / 12" Black and White wires (Input 120~277VAC) 18AWG / 12" Purple and Pink wires (Dimming 0-10VDC)
LED Quantity	48pcs. CW + 48pcs. WW
Driver Part Number	T1M1UNV0700-30L
Module Part Number	VMU095023RD9TWA
Weight	320g / 0.71lbs.
Packaging: Master Carton	20pcs
Maximum Screw Installation Torque	35in-lb (560in-ozf)
Safety/Compliance	Component: cURus Module File #E351548; Driver File #E342838 DC Engines Retrofit Kits: cULus Classified 1598C File # E365124 RoHS Compliant Dry and Damp Location Energy Star Luminaire 2.2 Listed and CSD ^①
RFI/EMI	FCC Part 15B Consumer, EN55015
Input Surge Test	2.5kV Common and Differential mode (Per ES Ring Wave Test)
Sound Rating / Noise	A / <24 dBA
Output Type	Class 2 (approved for luminaires glass or plastic lenses)
PCB Material / Connector Qty / Em. Connection	CEM1 / 2 / Yes
Warranty	5 years @ Max. Tc 105°C (module) and 76°C (Driver) from the date of manufacture

① See page #4 "Certification Chart" for exact models.

② Measured electrical data per UL file

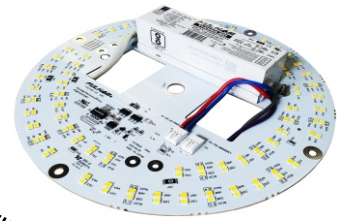

VKMUNV018RD930A



CCT Selection Indication

1. The VividHorse DC Engine Retrofit Kit is a dual-channel LED product, that allows for CCT selection via the dip switch on the PCB. Available CCTs include 2700K, 3000K, 3500K, 4000K, 4500K and 5000K.
2. A pre-set CCT will come from the factory. Check the product label or packaging to see the pre-set CCT level.
3. Change the dip switch position to “ON” (1~6) to set the desired CCT level.

NOTE: ONLY keep one dip switch in the “ON” position, not doing so may result in an undesired CCT.

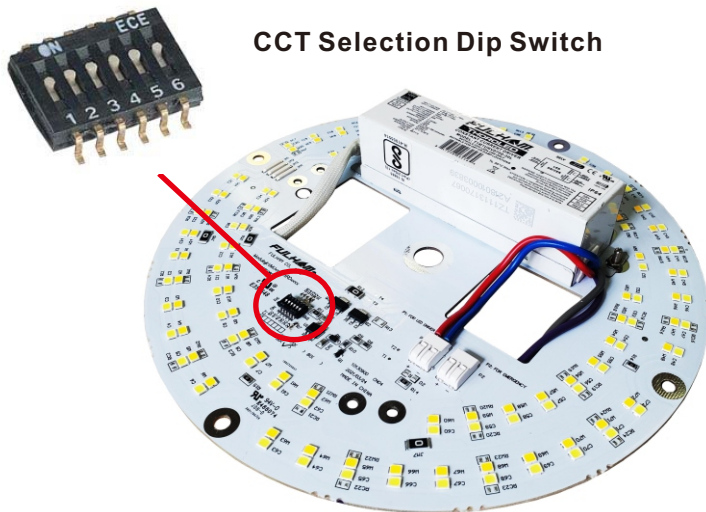

CCT Selection Dip Switch

CCT Indication Table

	1	2	3	4	5	6
2700K	ON	OFF	OFF	OFF	OFF	OFF
3000K	OFF	ON	OFF	OFF	OFF	OFF
3500K	OFF	OFF	ON	OFF	OFF	OFF
4000K	OFF	OFF	OFF	ON	OFF	OFF
4500K	OFF	OFF	OFF	OFF	ON	OFF
5000K	OFF	OFF	OFF	OFF	OFF	ON

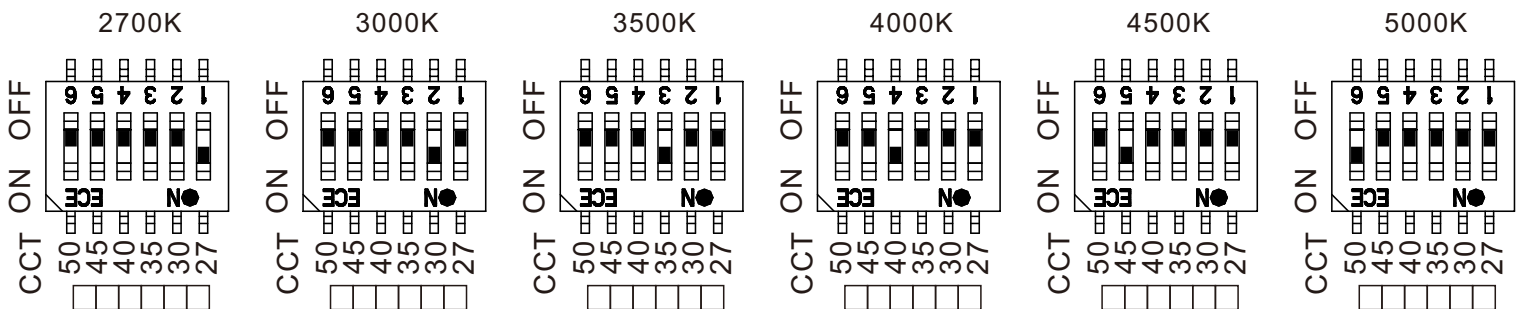

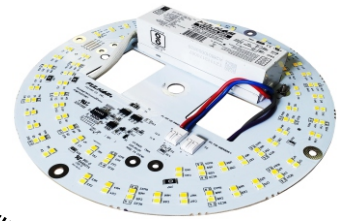

VKMUNV018RD930A



Electrical and Optical Specifications

CRI	DC Engine Retrofit Kit Part Number	Selected CCT	Input Power	Nominal Luminous Flux @ 90 CRI	Engine Efficacy @ 90 CRI
90	VKMUNV018RD930A	2700K	21W	2540 lumens	121 lm/W
		3000K	21W	2575 lumens	122 lm/W
		3500K	21W	2615 lumens	124 lm/W
		4000K	21W	2650 lumens	126 lm/W
		4500K	21W	2650 lumens	126 lm/W
		5000K	21W	2650 lumens	126 lm/W

Light Distribution

Zone	Zone Flux	Zone Flux%	Sum Zone Flux	Sum Zone Flux%
0 ~ 10	83.2	3.3%	83.2	3.3%
10 ~ 20	239.9	9.5%	323.1	12.7%
20 ~ 30	358.0	14.1%	681.1	26.9%
30 ~ 40	439.8	17.4%	1120.9	44.2%
40 ~ 50	463.2	18.3%	1584.1	62.5%
50 ~ 60	415.1	16.4%	1999.2	78.9%
60 ~ 70	308.6	12.2%	2307.8	91.1%
70 ~ 80	167.7	6.6%	2475.5	97.7%
80 ~ 90	44.4	1.8%	2519.9	99.4%
90 ~ 180	14.7	0.6%	2534.6	100.0%

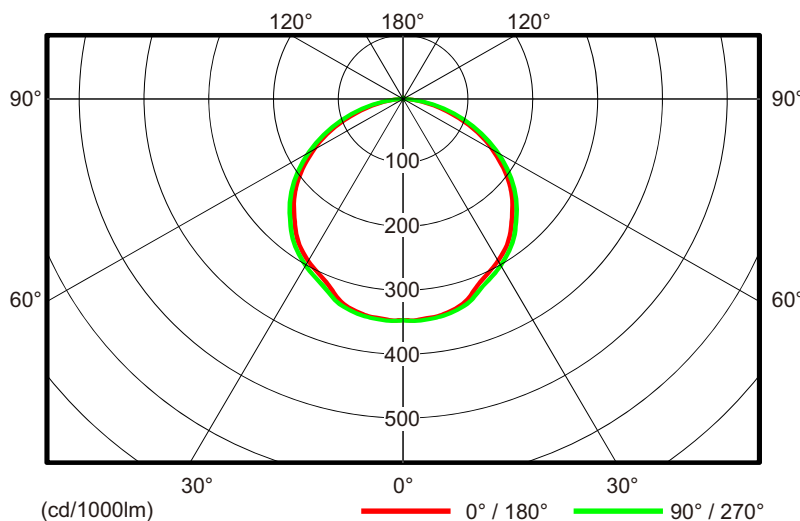

NOTES:

- 1) Electrical and optical specifications are based on Tc mod = 25°C. Reference Amb. Temp. vs Rel. Lum. Flux for other temperatures.
- 2) Performance for these components have been tested in accordance with Energy Star.
- 3) Refer to Energy Star CSD or Luminaires 2.2 for actual measurements on specific part numbers. Energy Star testing is done at elevated case temperature.
- 4) Specifications are subject to change without notice.
- 5) 70CRI & 80CRI are NOT available.

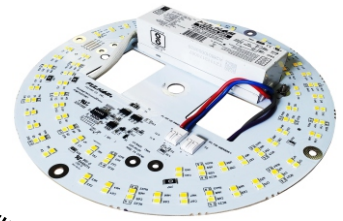

VKMUNV018RD930A



Thermal Specifications

③ DC Engine Retrofit Kit

Storage Temperature Range	-35°C to 100°C / -31°F to 212°F
Operating Ambient Temperature Range	-35°C to 60°C / -31°F to 140°F
Maximum Driver Case Temperature	85°C / 185°F
Maximum Module Case Temperature	105°C / 221°F

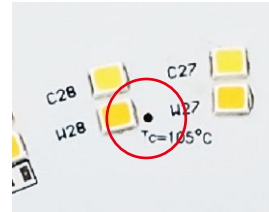

Tc located on module

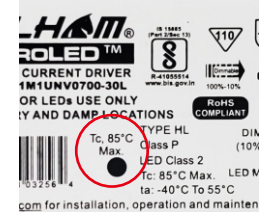

Tc located on driver

LED Driver Lifetime vs. Tcase

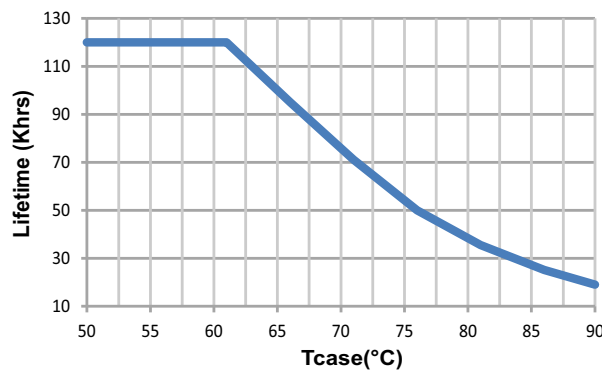

Failure Rate Info based upon MTBF modeling:
90% survivals at end of life @ ≤Tc lifetime rating

Thermal De-Rating: Tc vs. Luminous Flux

Module Case Temperature (Tc)	Total Vf Multiplier	Luminous Flux Multiplier
25°C	1.000	1.000
30°C	0.998	0.992
35°C	0.995	0.984
40°C	0.993	0.976
45°C	0.990	0.967
50°C	0.988	0.958
55°C	0.986	0.949
60°C	0.984	0.940
65°C	0.982	0.931
70°C	0.980	0.922
75°C	0.978	0.913
80°C	0.977	0.904
85°C	0.976	0.895
90°C	0.974	0.886
95°C	0.973	0.877
100°C	0.971	0.867
105°C	0.969	0.858

NOTES:

- 1) Refer to DC Engine Retrofit Kit Installation Instructions for further detail.
- 2) This DC Engine Retrofit Kit can retrofit any luminaire with a dimension/volume greater or equal to the minimum dimensions shown below and on the Installation Instructions.
- 3) This DC Engine Retrofit Kit can be used with luminaires similar to the one illustrated on the Installation Instructions.

③ Suitable for surface mounted luminaire with minimum dimensions or volume: 10" diameter with a height of 3" or 30 cubic inches

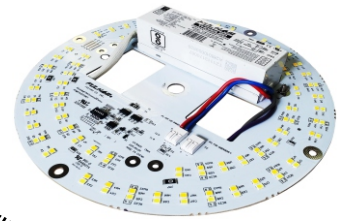

VKMUNV018RD930A



Certification Chart

Classification	Model	VKMUNV018RD930A
		YES
		YES (Driver & Module)
		YES
		YES (Exclude 4500K)
		YES (Exclude 4500K)

Energy Star™ TM-21 Calculator Data

Tc Module	Reported L70	Reported L90
85°C	>60,000 Hrs	40,000 Hrs
96°C	>60,000 Hrs	36,000 Hrs
105°C	>60,000 Hrs	33,000 Hrs
Tc Module	Calculated L70	Calculated L90
85°C	131,000 Hrs	40,000 Hrs
96°C	117,000 Hrs	36,000 Hrs
105°C	106,000 Hrs	33,000 Hrs

1) Energy Star CSD:

https://www.energystar.gov/products/lighting_fans/certified_lighting_subcomponent_database_csd

2) Energy Star Listed:

https://www.energystar.gov/productfinder/product/certified-light-fixtures/results?scrollTo=342&search_text=fulham&fixture_type_isopen=&markets_filter=United+States&zip_code_filter=&product_types=Select+a+Product+Category&sort_by=light_output_lumens&sort_direction=asc&page_number=0&lastpage=0

LED Lumen & Color Maintenance Data per LM-80 report and TM-21 Calculator

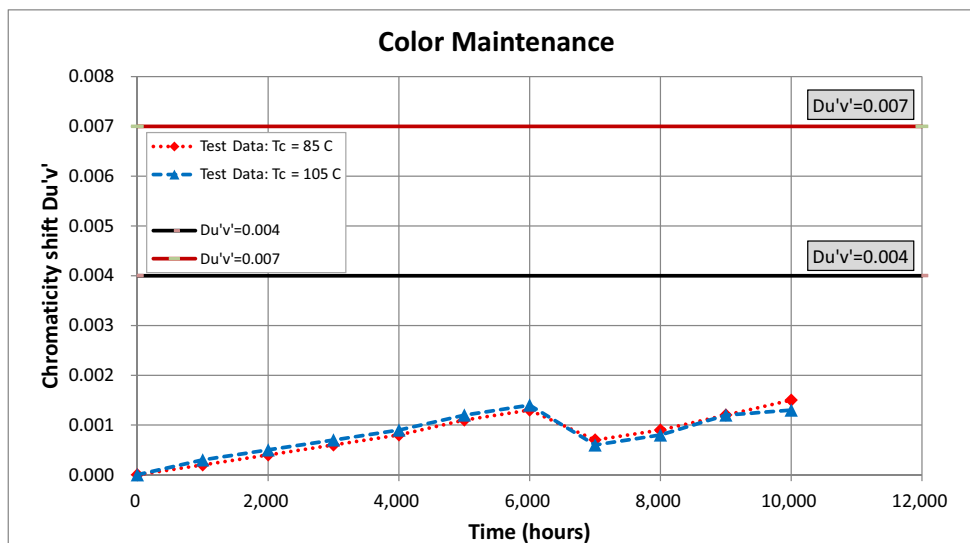
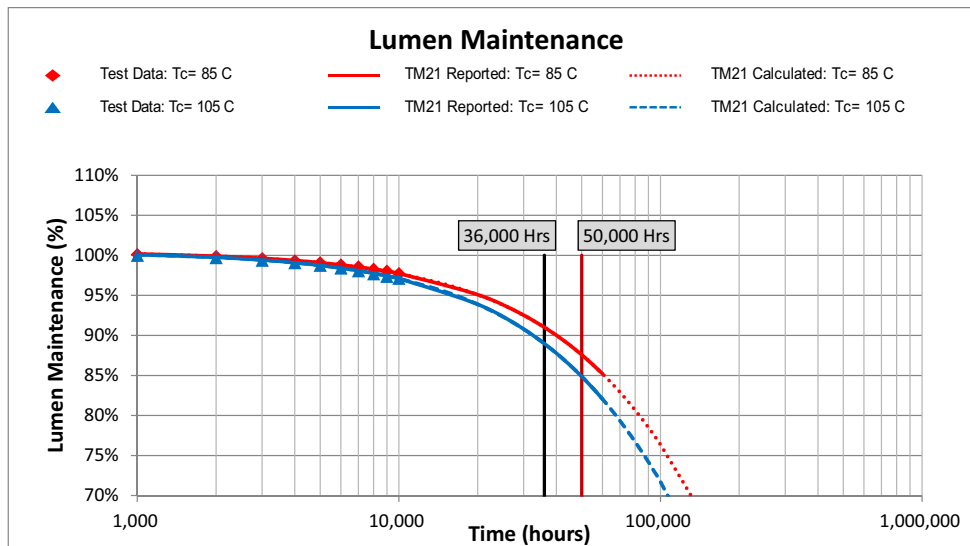

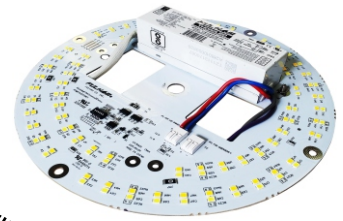

VKMUNV018RD930A



Mechanical Drawings

(Scale 3 : 5)

TOP VIEW

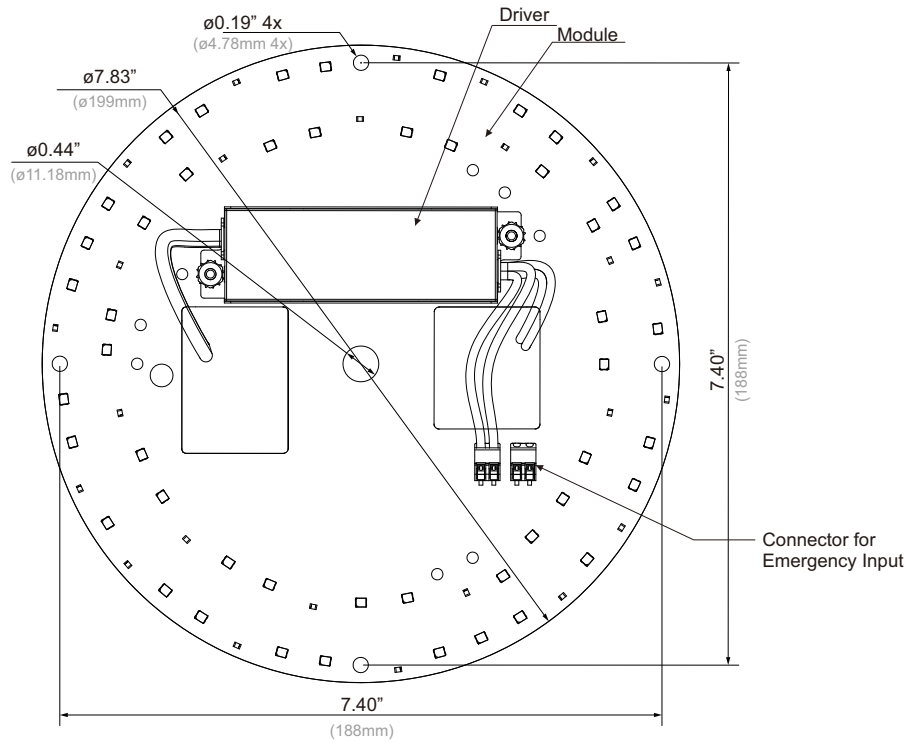

Overall Dimensions

Diameter	7.83" [199mm]
Height	1.18" [29.89mm]
Wire Length	
AC Input (Black / White)	12" [304.8mm]
0-10V Dimming Purple (10v+) Pink (10V-)	12" [304.8mm]

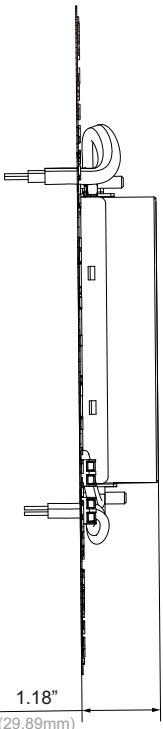

SIDE VIEW

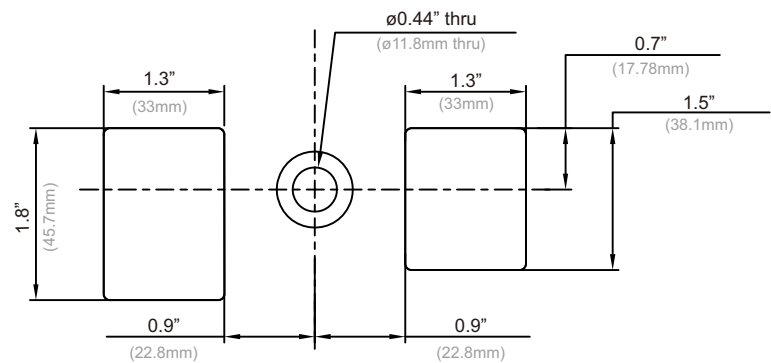

PARTIAL VIEW

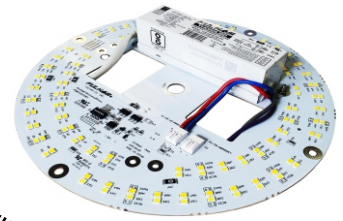

VKMUNV018RD930A



DC Engine Retrofit Kit Equivalency Chart: FLUO to LED

DC Engine Retrofit Kit (7.8" Round)				CFL					
DC Engine Retrofit Kit Part Number	System Wattage	Lumen Output	Efficacy	CFL Style	Lamp Wattage	# of Lamps	Total Wattage	Lumen Output	Efficacy
VKMUNV018RD930A	21W	2650 lm (4K/90CRI)	126 lm/W	Quad	13W	1	13W	775 lm	59 lm/W
					18W	1	18W	1075 lm	
				Triple	13W	1	13W	825 lm	63 lm/W
					18W	1	18W	1020 lm	
				Quad	13W	2	26W	1550 lm	59 lm/W
					26W	1	26W		
				Triple	13W	2	26W	1650 lm	63 lm/W
					26W	1	26W		
				Circline T5	22W	1	22W	1530 lm	69 lm/W
				Circline T9	22W	1	22W	775 lm	35 lm/W

NOTES:

- 1) LED is a point source and FLUO is 360, there is more light lost with FLUO especially during the reflection. Therefore it is recommended to use a 65 percent of the original light source total lumens when converting FLUO to LED. For example original FLUO lumens of 2000 x .65% = 1300 LED lumens. This is only a recommendation, and the installer should consider other factors for the application.
- 2) For reference only, several factors apply.

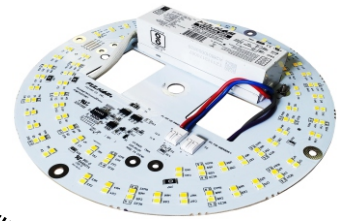

VKMUNV018RD930A



DC Engine Retrofit Kit with Emergency Options

NOTE: Emergency systems are not UL classified for field installation.

Engine/Kit Part Number	Emer. Driver Part Number	Battery Wattage	Battery Part Number	Harness (mA)	LED Vf (V)	LED If (mA)	Total Power (W)	Total Lum. Output (lm)	Eff. (lm/W)
VKMUNV018RD930A	FHS2-UNV-36L/ FHS2-UNV-56S	4W	FHSBATT8-AA9 FHSBATL3-1	FHS-HARNESS-175	21.5	175	3.8	720 [Ⓢ]	191
	FHSCP-UNV-5WL	5W	N/A	N/A	21.8	228	5.0	934	187
	FHSCP-UNV-10P-L-SD	5W	FHSBATL3-1.5-SD	N/A	21.8	228	5.0	934	187
	FHS2-UNV-36L	6W	FHSBATL6-.6	FHS-HARNESS-250	21.8	250	5.5	1022 [Ⓢ]	187
	FHSCP-UNV-10P-L-SD	6W	FHSBATL9-.6-SD	N/A	21.9	368	6.0	1124	187
	FHSCP-UNV-7.8WL	7.8W	N/A	N/A	22.2	354	7.8	1428	183
	FHS2-UNV-36L/ FHS2-UNV-56S	8W	FHSBATL3-1.5 FHSBATL3-1.5S	FHS-HARNESS-350	22.2	350	7.8	1412 [Ⓢ]	182
	FHS2-UNV-36L	10W	FHSBATL9-.6	FHS-HARNESS-450	22.4	450	10.1	1791 [Ⓢ]	178
	FHSCP-UNV-10P-L-SD	10W	FHSBATL3-3-SD FHSBATL6-1.5L-SD [Ⓢ]	N/A	22.4	444	10.0	1769	177
	FHSCP-UNV-10.7WL	10.7W	N/A	N/A	22.5	474	10.7	1880	176
	FHSCP-UNV-13.7WL	13.7W	N/A	N/A	22.8	600	13.7	2328	170
	FHS2-UNV-36L/ FHS2-UNV-56S	16W	FHSBATL3-3	FHS-HARNESS-650	22.9	650	14.9	2496 [Ⓢ]	168
	FHSCP-UNV-17WL	17W	N/A	N/A	23.1	735	17.0	2772	163

NOTES:

- 1) For reference only, several factors apply.
 - 2) Emergency systems are not UL classified for field installation.
- Ⓢ These batteries do not include mounting means, separate mounting brackets are available
- Ⓢ Initial lumen output. Will reduce to no less than ~65% of total lumen output.

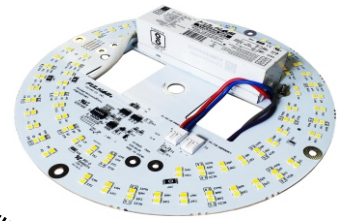

VKMUNV018RD930A



Wiring Diagram: Standard Option

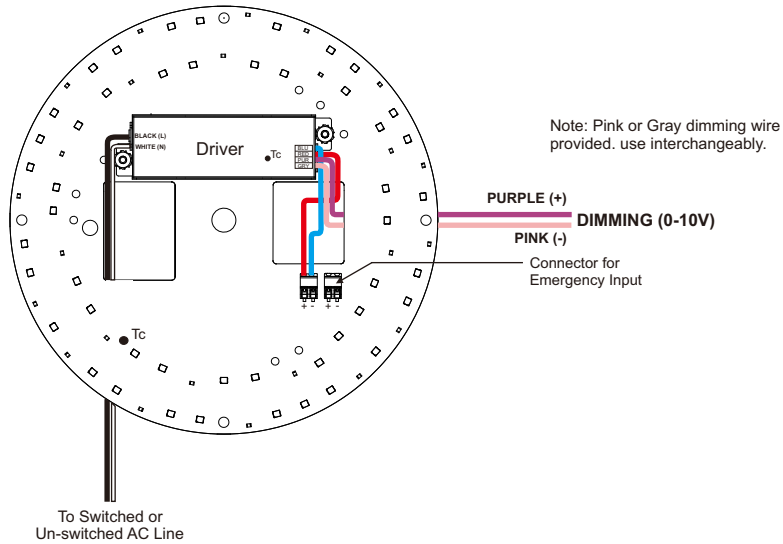

Wiring Diagram: HotSpot2 (FHS2) EM- Pass Through (Recommended for non-Fulham LED EM)

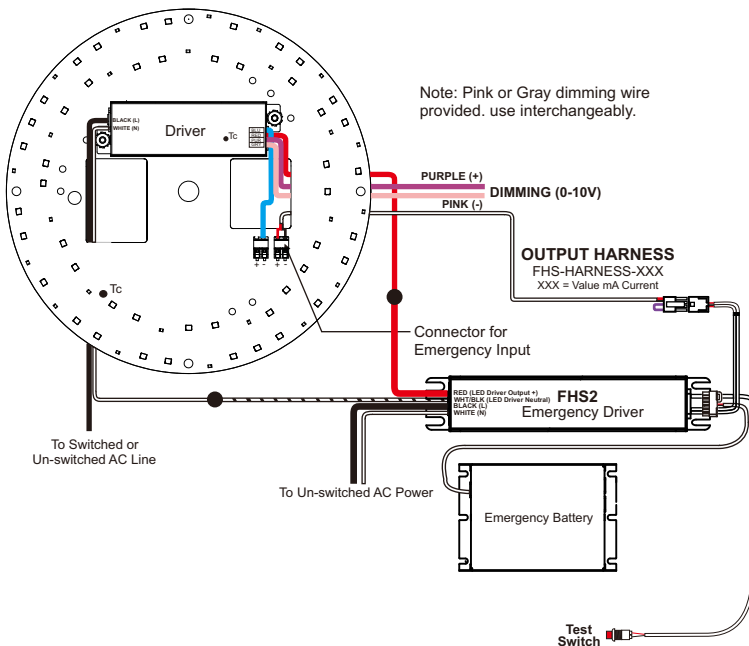

Wiring Diagram: HotSpot2 (FHS2) EM- In Parallel (Recommended for Fulham LED EM)

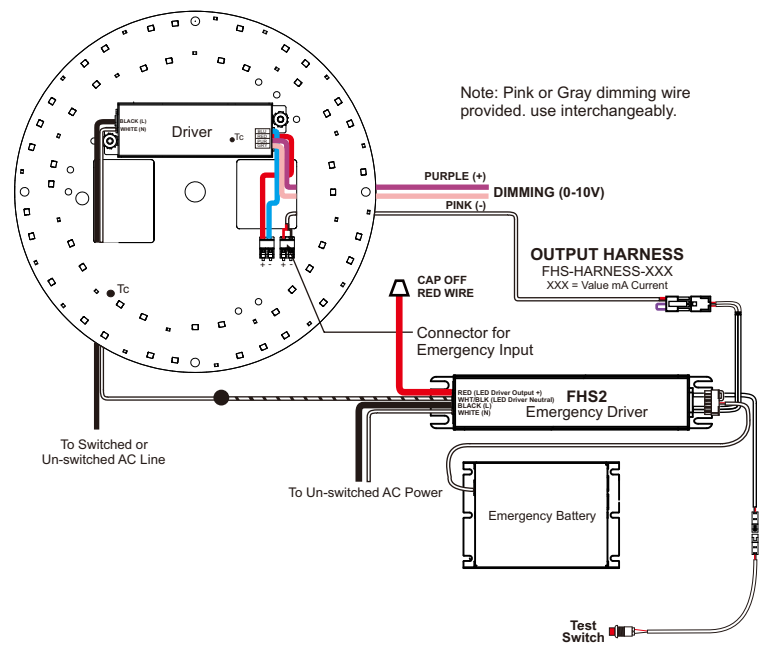

NOTES:

- 1) For reference only, several factors apply.
- 2) Emergency systems are not UL classified for field installation.

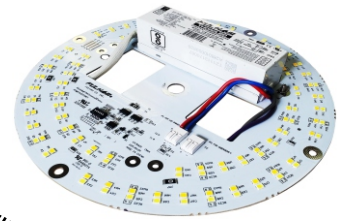

VKMUNV018RD930A



Wiring Diagram: Constant Power with conduit (FHSCP) EM- Pass Through (Recommended for non-Fulham LED EM)

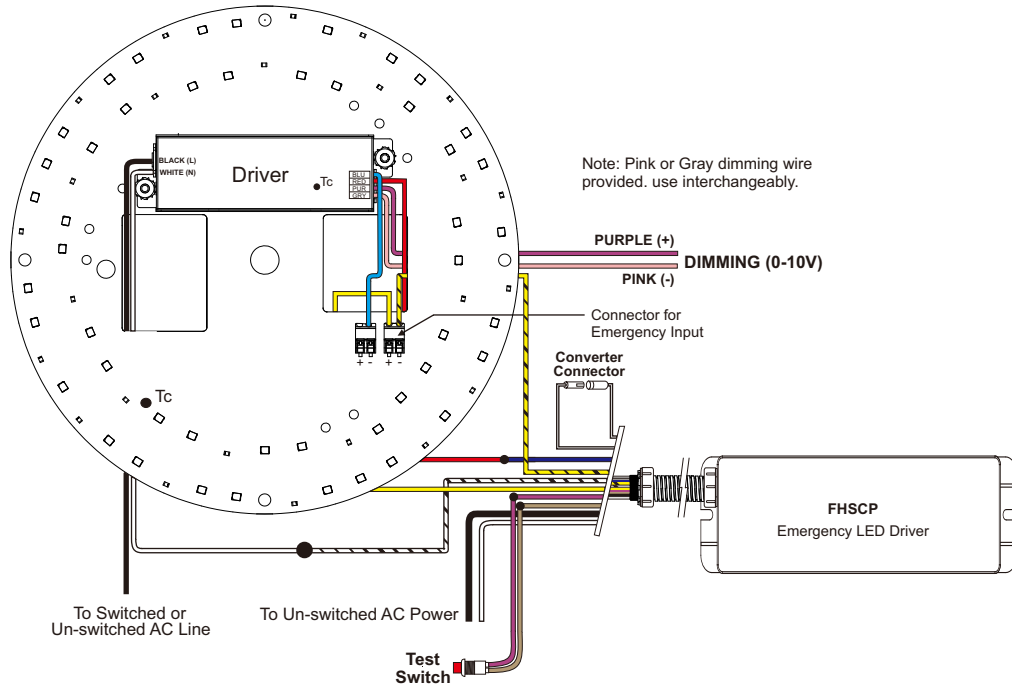

Wiring Diagram: Constant Power with conduit (FHSCP) EM- In Parallel (Recommended for Fulham LED EM)

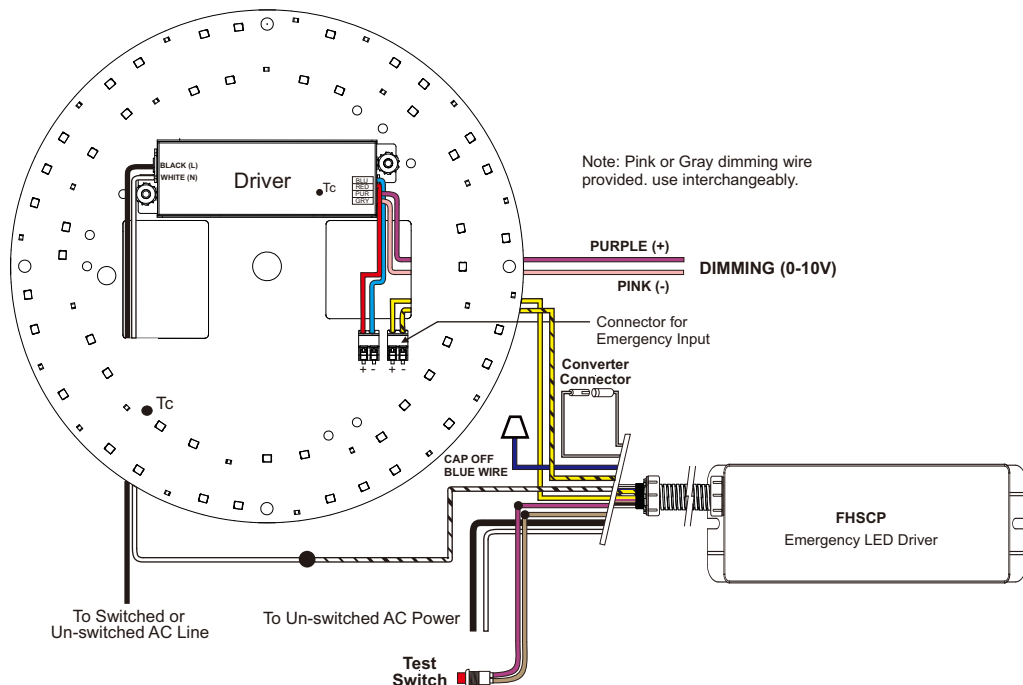

NOTES:

- 1) For reference only, several factors apply.
- 2) Emergency systems are not UL classified for field installation.

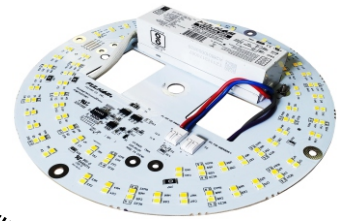

VKMUNV018RD930A



Wiring Diagram: Parallel Wiring (FHSCP-UNV-10P-L-SD)

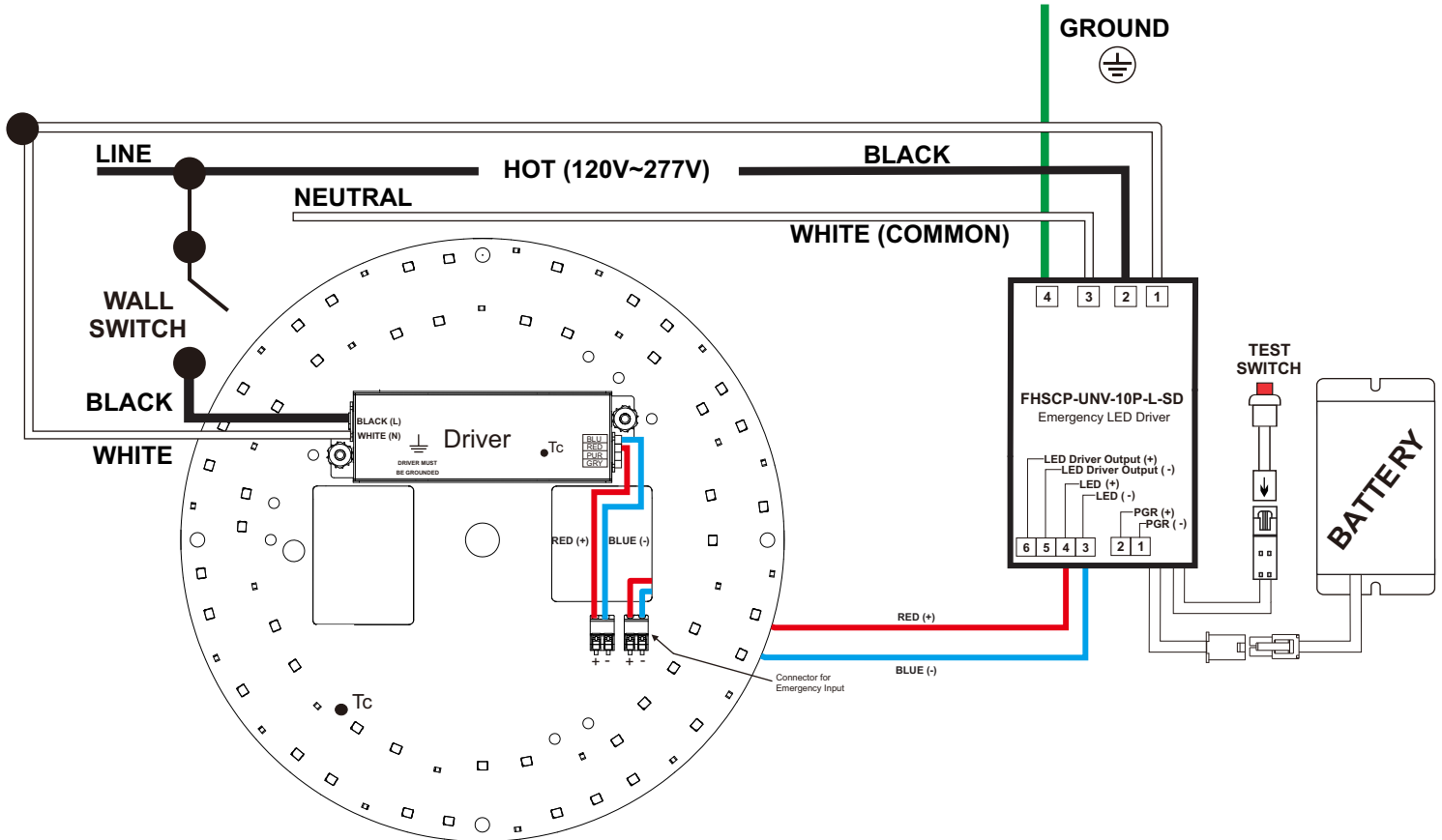

NOTES:

- 1) For reference only, several factors apply.
- 2) Emergency systems are not UL classified for field installation.

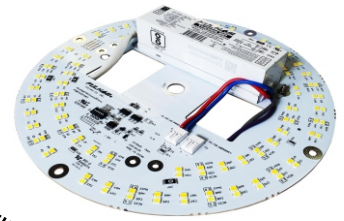

VKMUNV018RD930A



Color and Binning

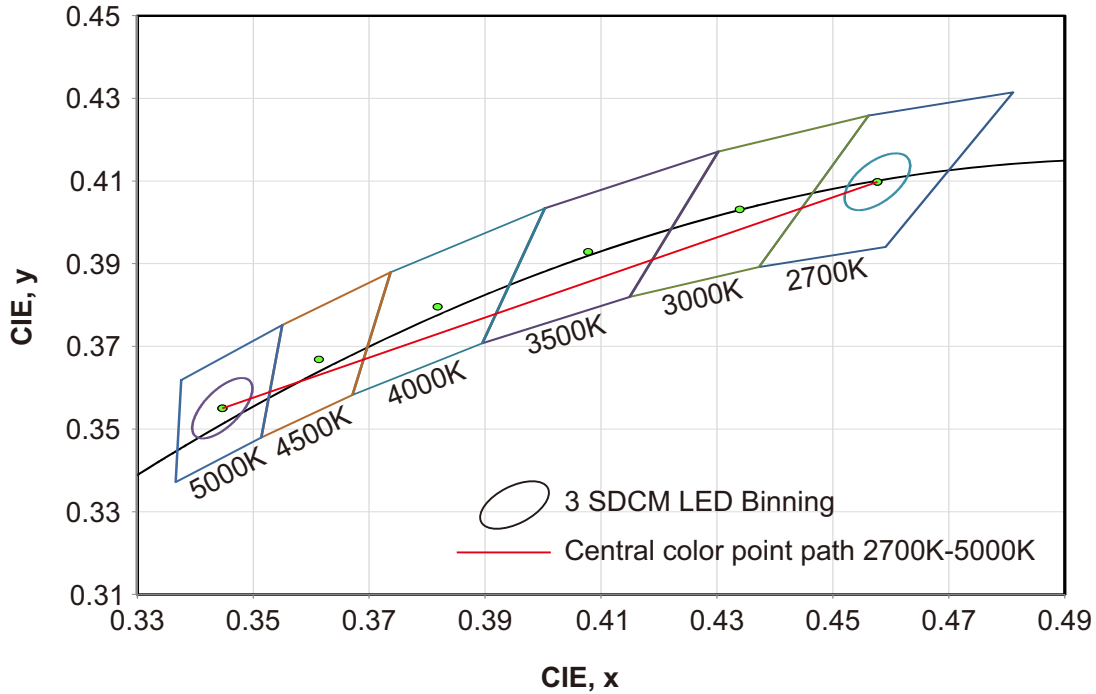

Optical Spectrum

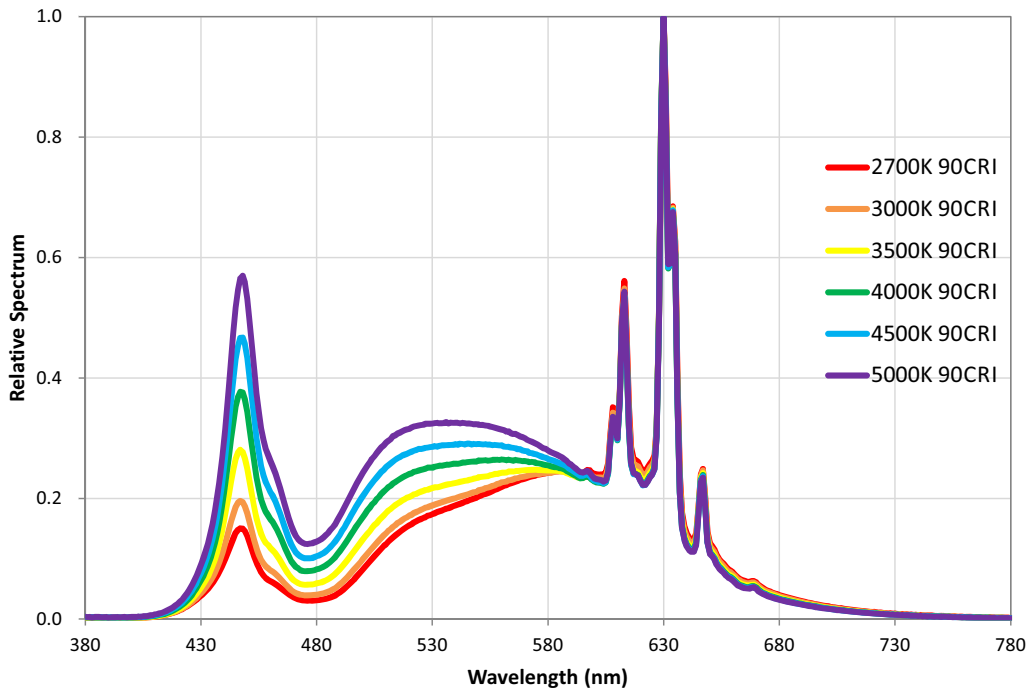

NOTES:

- 1) The Color and Binning and Optical Spectrum charts are for reference only. For more detailed info, contact factory.
- 2) Reference Samsung Chromaticity Diagram for Color and Binning. Binning per ANSI C78.377-2015 @ 25°C; 3 SDCM.
- 3) The Optical Spectrum values vary depending on product type and color rank.

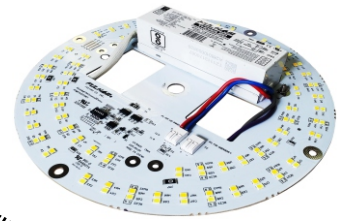

VKMUNV018RD930A



Guidelines

Reduced Flicker Operation Feature

- DC Engine models have added circuitry to help reduce the Flicker when operated on the 50/60Hz power lines. The Flicker percentage on these models is below 30% when operated at line voltage, per CEC requirement.

Termination Notes

- A luminaire disconnect UL listed connector is included, as part of DC Engine Retrofit Kit to meet Energy Star requirements.
- Use solid wire size 18AWG/12" per pole, rated at max 600V load and 105°C operating temperature.
- Strip wires to 11-13mm (0.47in.).
- Connector not for multiple use.
- For additional information on Wago's 873 Series Lumi-Nuts® connector, please visit:



Environmental Rating

- DC Engine Retrofit Kit are rated for dry and damp locations.

Fastening to Luminaire

- When installing by "mounting thru holes" (recommended), use any screw with diameter less than 0.13in. [3.4mm]. Mount on a flat surface and use all 4 mounting holes to ensure good contact between back side of DC Engine Retrofit Kit and mounting surface. Refer to max specified torque for installation. Suggested screw sizes: #5 or M3 Pan Head screw.

Electrostatic Sensitive Product (ESD)

- Fulham LED products should be handled with proper measures to protect against any potential ESD damage.
- When servicing, personnel should be ground and direct contact with LED should be avoided.

Thermal Management

- Proper thermal management should be employed to ensure life and reliability of product.

Wiring

- Intended for UNV (120-277V) application ONLY.
- Connect the Black wire from the DC Engine Retrofit Kit to the building Line by using the proper connectors or wire nuts.
- Connect the White wire from the DC Engine Retrofit Kit to the building/source Neutral by using the proper connectors or wire nuts.
- DC Engine Retrofit Kit and luminaire must be grounded.

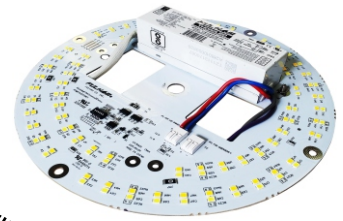

VKMUNV018RD930A



Part Number Matrix

V K M UNV 018 RD 9 30 A

Product Line V = VividHorse[®]
Compliance K = DC Engine Retrofit Kit (cULus Classified)
Dimming M = 0-10V
Input Voltage UNV = 120V~277V
Estimated Power 018 = 18W (Typ. 21W)
Shape RD=Round
CRI 9 = 90
Color Temperature 30 = CCT Selectable, Factory Default 3000K

- Ⓢ Standard Product offering. Default CCT setting is 3000K.
- Ⓢ DC Engine Retrofit Kit includes mounting hardware, retrofit labels, and installation instructions.

Product Image: 21W Round DC Engine Kit

VKMUNV018RD930A

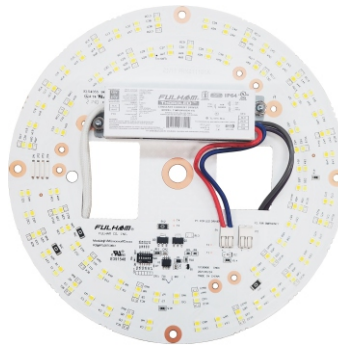

This luminaire has been modified and can no longer operate the originally intended lamp. REPLACE ONLY WITH FULHAM ELECTRONIC CO. : VKMUNV018RD930A

Ce luminaire a été modifié et ne peut plus utiliser la lampe prévue à l'origine. REMPLACER UNIQUEMENT AVEC FULHAM ELECTRONIC CO. : VKMUNV018RD930A



Hardware Kit: TLC-HW08

UNV DC Engines Retrofit Kits with 0-10V Dimming : Hardware, Quick disconnect, Labels & Installation Instructions

Packaging

Master Carton

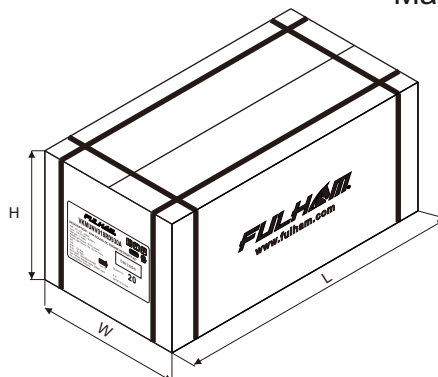

OUTER DIMENSION		
L	W	H
21.65"(550mm)	15.75"(400mm)	9.45"(240mm)
Net Weight	Gross Weight	QUANTITY
14.52 lbs. (6.6 kg)	20.24 lbs. (9.2 kg)	20pcs.