



## **INSTALLATION INSTRUCTIONS**

**VividHorse 120VAC CCT Selectable AC Engine Retrofit Kit**

**VJT120010AC9TWB**

Reference spec sheet for full part numbers



# LED LIGHT ENGINE APPLICATION PROGRAM

## MANUAL FOR LED LIGHT ENGINE KIT INSTALLATION

### 1.0 INSTALLATION WARNINGS

1. "THIS PRODUCT MUST BE INSTALLED IN ACCORDANCE WITH THE APPLICABLE INSTALLATION CODE BY A PERSON FAMILIAR WITH THE CONSTRUCTION AND OPERATION OF THE PRODUCT AND HAZARDS INVOLVED."
2. "WARNING - Risk of fire or electric shock. LED Retrofit kit installation requires knowledge of luminaire electrical systems. If not qualified, do not attempt installation. Contact a qualified electrician."
3. "WARNING - Risk of fire or electric shock. Install this kit only in the luminaires that has the construction features and dimensions shown in the photographs and/or drawings and where the input rating of the retrofit kit does not exceed the input rating of the luminaire."
4. "WARNING - To prevent wiring damage or abrasion, do not expose wiring to edges of sheet metal or other sharp objects."
5. "WARNING - Risk of fire or electric shock. Luminaire wiring and electrical parts may be damaged when drilling for installation of LED retrofit kit. Check for enclosed wiring and components."
6. "CAUTION - RISK OF FIRE. CONSULT A QUALIFIED ELECTRICIAN TO ENSURE CORRECT BRANCH CIRCUIT CONDUCTOR."
7. "THE RETROFIT KIT IS ACCEPTED AS A COMPONENT OF A LUMINAIRE WHERE THE SUITABILITY OF THE COMBINATION SHALL BE DETERMINED BY THE AUTHORITIES HAVING JURISDICTION. PRODUCT MUST BE INSTALLED BY A QUALIFIED ELECTRICIAN IN ACCORDANCE WITH THE APPLICABLE AND APPROPRIATE ELECTRICAL CODES. THE INSTALLATION GUIDE DOES NOT SUPERSEDE LOCAL OR NATIONAL REGULATIONS FOR ELECTRICAL INSTALLATIONS."
8. Only those open holes indicated in the photographs and/or drawings may be made or altered as a result of kit installation. Do not leave any other open holes in an enclosure of wiring or electrical components.

### 1.0 AVERTISSEMENTS D'INSTALLATION

1. CE PRODUIT DOIT ÊTRE INSTALLÉ SELON LE CODE D'INSTALLATION PERTINENT, PAR UNE PERSONNE QUI CONNAÎT BIEN LE PRODUIT ET SON FONCTIONNEMENT AINSI QUE LES RISQUES INHÉRENTS.
2. AVERTISSEMENT - Risque d'incendie ou de choc électrique. L'installation de ce nécessaire de modernisation exige une personne familière avec la construction et le fonctionnement du système électrique du luminaire et des risques associés. Toute personne qui n'est pas qualifiée ne doit faire aucune tentative d'installation et doit contacter une personne qualifiée.
3. AVERTISSEMENT - Risque d'incendie ou de choc électrique. N'installer ce nécessaire que dans les luminaires dont les caractéristiques de construction et les dimensions sont conforme à celles illustrées dans les photos et/ou les dessins et dont la puissance d'entrée nominale du nécessaire de modernisation ne dépasse pas celle du luminaire.
4. AVERTISSEMENT - Afin de prévenir l'endommagement ou l'abrasion des câbles, éviter tout contact entre ces derniers et le bord d'un objet tranchant tel qu'une tôle.
5. AVERTISSEMENT - Risk d'incendie ou de choc électrique. Le câblage du luminaire et les pièces électriques peuvent être endommagés lors du forage pour l'installation d'un kit de reconditionnement LED. Vérifiez le câblage et les composants inclus.
6. ATTENTION – RISQUE D'INCENDIE, CONSULTER UN ÉLECTRICIEN QUALIFIÉ POUR VOUS ASSURER QUE LES CONDUCTEURS DE LA DÉRIVATION SONT ADÉQUATS.
7. LE NÉCESSAIRE DE MODERNISATION EST ACCEPTÉ À TITRE DE COMPOSANT D'UN LUMINAIRE LORSQUE LA PERTINENCE DE LA COMBINAISON DOIT ÊTRE DÉTERMINÉE PAR LES AUTORITÉS COMPÉTENTES. LES PRODUITS DOIVENT ÊTRE INSTALLÉS PAR UN ÉLECTRICIEN QUALIFIÉ CONFORMÉMENT AUX CODES ÉLECTRIQUES APPLICABLES ET APPROPRIÉS. LES LIGNES DIRECTRICES D'INSTALLATION NE REMPLACENT PAS LES RÈGLEMENTS LOCAUX OU NATIONAUX SUR L'INSTALLATION ÉLECTRIQUE.
8. Seules les ouvertures indiquées sur les photos et / ou les dessins peuvent être faites ou modifiées à la suite de l'installation du kit. Ne laissez aucune autre ouverture sur le câblage ou le boîtier des composants électriques.

### 2.0 CCT SELECTION INDICATION

#### CCT Selection Indication

1. The VividHorse DirectAC Engine Retrofit Kit is a dual-channel LED product that allows for CCT selection via a dip switch on the PCB. Available CCTs include 2700K, 3000K, 3500K, 4000K and 5000K.
2. A pre-set CCT will come from the factory. Check the product label or packaging to see the pre-set level.
3. Change the CCT dip switch position to "ON" (1~5) to set the desired CCT level.
4. Setting all CCT dip switches to the "OFF" position will result in no light output.

**NOTE: ONLY keep one CCT dip switch in the "ON" position; failing to do so may result in an undesired CCT.**

**CCT Selection Dip Switch**

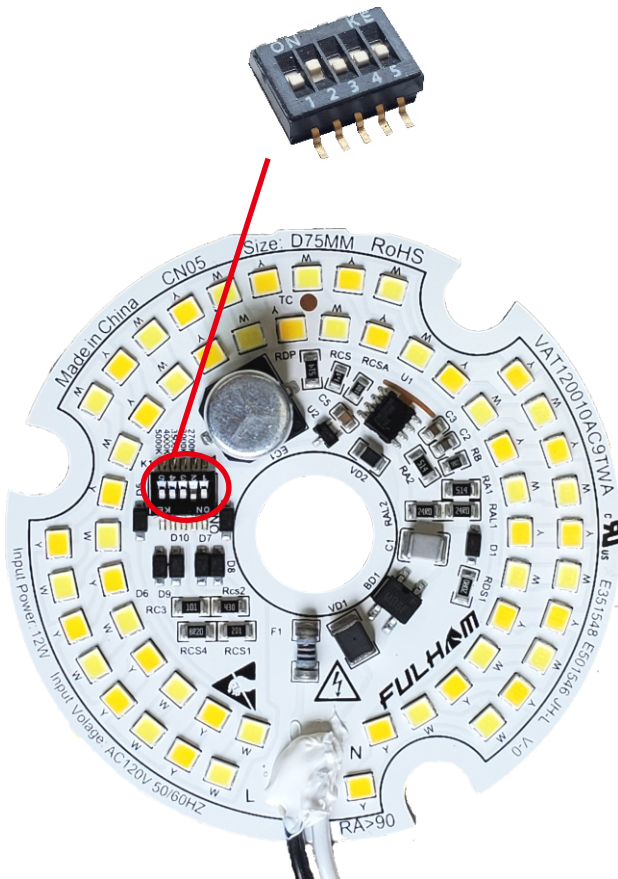

**CCT Indication**

	1	2	3	4	5
<b>2700K</b>	ON	OFF	OFF	OFF	OFF
<b>3000K</b>	OFF	ON	OFF	OFF	OFF
<b>3500K</b>	OFF	OFF	ON	OFF	OFF
<b>4000K</b>	OFF	OFF	OFF	ON	OFF
<b>5000K</b>	OFF	OFF	OFF	OFF	ON
<b>No Light</b>	OFF	OFF	OFF	OFF	OFF

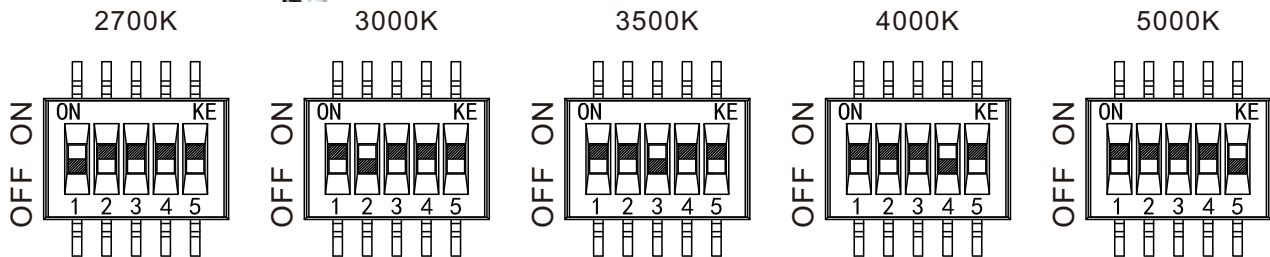

### 3.0 ORIGINAL LUMINAIRE DIMENSIONS

#### Original Luminaire

Mfr: RLR Industries - Model: Picture Frame Sconce

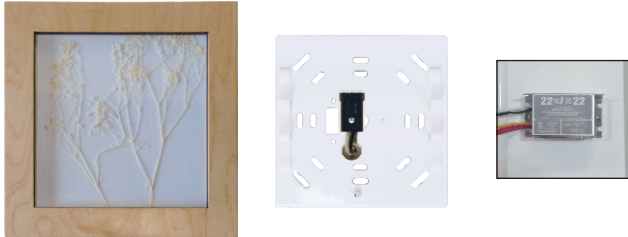

#### Minimum Luminaire Dimensions

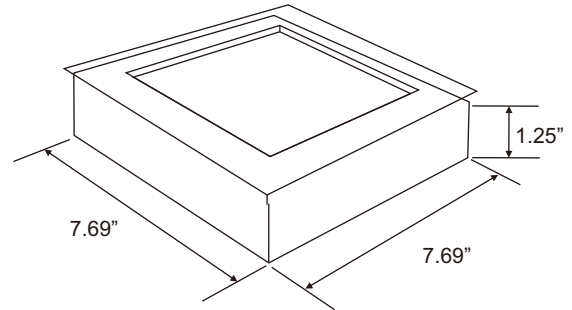

- Remove all the original luminaire parts, lamp, lampholder and ballast (only for Fluorescent) in order to begin the retrofit.
- Original luminaire diffuser and original ground wire will need to be kept for this retrofit.
- This Kit can be retrofitted into any surface wall or ceiling luminaire with a similar shape and diameter/height greater or equal to the minimum dimensions described above, or volume greater or equal to 73.87 cubic inches.
- All target luminaires shall conclude a metal back plate at size 3.5" x 3.5" or larger with grounding means.

**NOTE:** Wire on dedicated lighting branch circuit. Do not wire on same branch circuit as motors, heating elements, inductive type loads or heavy machinery which may introduce spikes, noise and other abnormalities onto the Line. Doing so may result in damage to the unit or abnormal lighting conditions.

### 4.0 RETROFIT KIT COMPONENTS

Retrofit kit components will be provided as listed below:



Direct AC LED Engine



Mounting Hardware

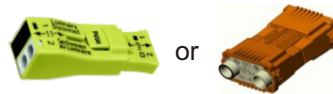

Input Power Connector

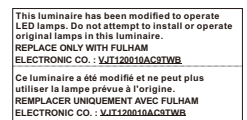

Retrofit Label

### 5.0 RECOMMENDED TOOLS (Not Included)

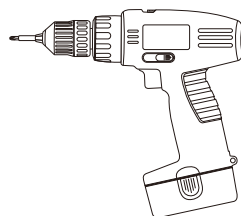

Power Drill W/ Philips Bit

**6.0 RETROFIT KIT DESCRIPTION**

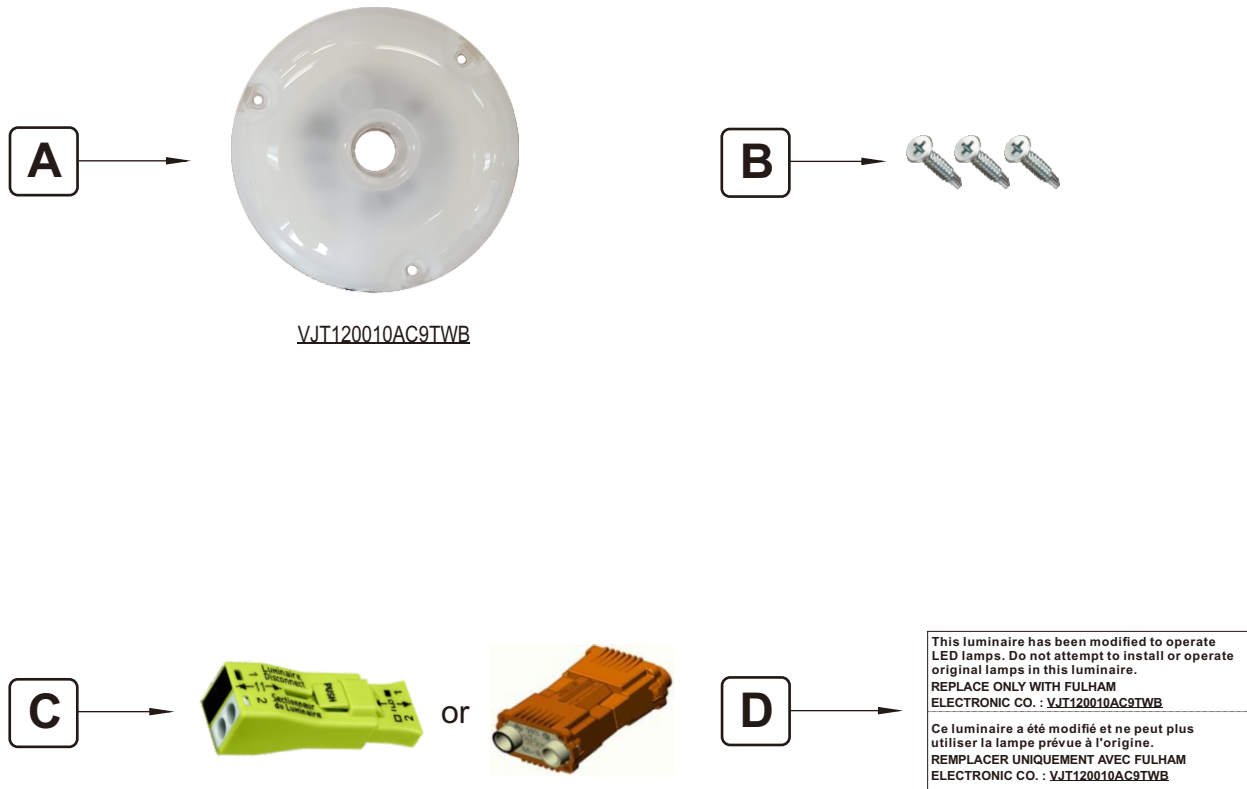

ITEM	DESCRIPTION	QTY
<b>A.</b>	Direct AC LED Engine	1
<b>B.</b>	6-20 X 5/8" Flat Head Self Drilling Screws	3
<b>C.</b>	Input Power Connector	1
<b>D.</b>	Retrofit Label	1



### 7.0 RETROFIT KIT ASSEMBLY

1. Start by removing the original lamp, lampholder and ballast (only for Fluorescent) from the luminaire. See figure 1.

**NOTE:** The original luminaire ground wire will need to be kept for this retrofit.

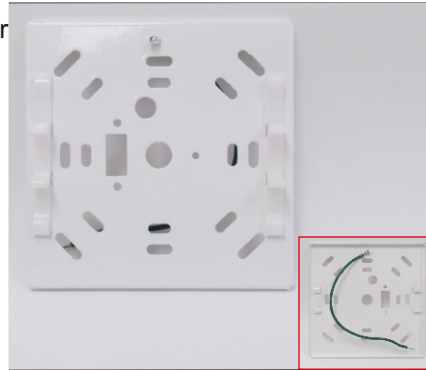

Figure 1

2. Center the DirectAC Engine (A) in the luminaire so that the line voltage cables are aligned with one of the holes found in the luminaire plate. See figure 2.

**NOTE:** LED Engine must make direct contact with the back plate when installed in order to provide sufficient heat sinking to properly manage thermals for safety and warranty purposes.

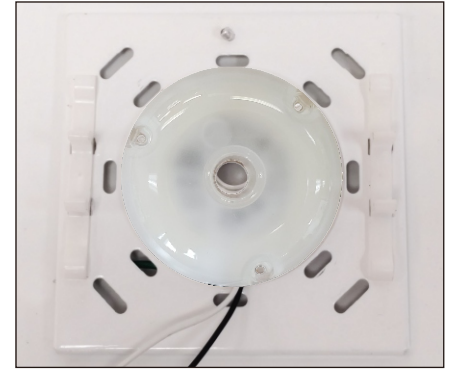

Figure 2

3. Use the supplied self-drilling screws (B) to attach the DirectAC Engine (A) to the luminaire plate. See figure 3.

**NOTE:** All screws provided must be used to ensure good thermal contact to surface.

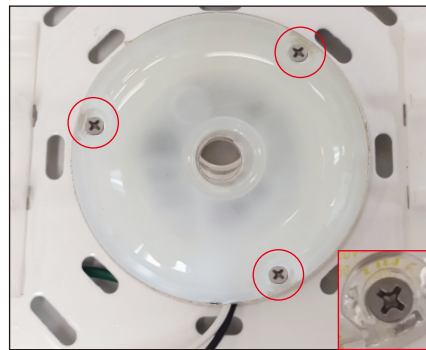

Figure 3

4. Feed line voltage cables from the DirectAC Engine (A) through one of the holes found in the luminaire. See figure 4.

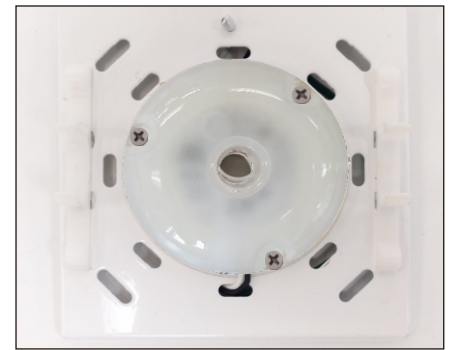

Figure 4

5. Place the provided Retrofit Label (E) on the outer areas of the luminaire where DirectAC Engine (A) was just installed. Labels must be clearly visible and should not be obscured by line voltage cables. See figure 5.



Figure 5

6. Completed assembly should look like figure 5.



Figure 6

7. Luminaire is now ready to be installed. Please see below for instructions on connecting line voltage to the luminaire.

8. Re-attach and secure the lens once installation is completed, retrofit should look like figure 6.

This luminaire has been modified to operate LED lamps. Do not attempt to install or operate original lamps in this luminaire.  
REPLACE ONLY WITH FULHAM ELECTRONIC CO. - VJZ12W12W-RD  
Ce luminaire a été modifié et ne peut plus utiliser la lampe prévue à l'origine.  
REMPLEZ UNIQUEMENT AVEC FULHAM ELECTRONIC CO. - VJZ12W12W-RD

**Note:** For all models, live parts should not be accessible after installation.

### Connecting Power to the DirectAC Engine:

- 1) Connect the green wire (Ground) from the luminaire to the Ground that is being fed by the power source. Connect these two wires by using a wire connector with a minimum 18AWG rating.
- 2) Connect the white wire (Neutral) from the DirectAC Engine to the Neutral being fed by the power source. Connect these two wires by using a wire connector with a minimum 18AWG rating.
- 3) Connect the Black wire (Line) from DirectAC Engine to the Line being fed by the power source. Connect these two wires by using a wire connector with a minimum 18AWG rating.

### 8.0 WARRANTY

- Please refer to DirectAC Engine kit spec sheet for warranty information