

- LED Driver with integrated emergency backup
- Universal Voltage: 120-277V ~, 50/60Hz
- Output Wattage: 40W Max.
- Output Current: 250-1400mA(Default 250mA)
- Output voltage range of 11-55V $\overline{\text{---}}$
- Compact case with side leads
- Meets UL 924 & NFPA 101
- EBD (Emergency Battery Disengage)

This Driver Will Operate The Following LED Modules: Any LED module designed to accept input voltage range of 11-55VDC and can operate up to current of 250-1400mA.

General Specifications

Input Voltage	120-277VAC, 50/60Hz
Input Current	0.43A @ 120VAC
Input Power	54W
Power Factor	>0.9
THD	<20%
Standby Input Power	<0.85W
Driver Type	Constant Current
Output Current	250-1400mA [TPSB 100 (Program Box), Figure 1]; Default Current 250mA
Output Voltage Range	11-28VDC (250-1400mA) , 11-40VDC (250-1000mA) , 11-55VDC (250-730mA)
Output Power	40W Max
	5W or 10W @ Emergency Mode (Min. 180 Minutes @ 5W, Min. 90 Minutes @ 10W)
Number of Output Channels	1 Channel
Dimming Controller Type / Dimming Range	0-10V / 100% - 1%,0% (Figure 2) / Custom Dimming Curve / Dimmed To Off
RFI/EMI	FCC Part 15A Non-Consumer
Output Type	LED Class 2
Battery Type	LiFePO4 6.4VDC (Part# FHSBATL2-3.2L)
Battery Capacity Available	3200mAh
Battery Recharge Time	12 Hours
Test Switch Remote Mounting Distance	20' (6m) Max.
Max. Case Temperature	85°C (185°F)
Ambient Operating Temperature Range	0°C to 48°C(32°F to 118.4°F)
Sound Rating	A
Input Surge Protection	Line-Neutral 3kV , Line & Neutral-Ground 6kV , Ring Wave ANSI/IEEE62.41
Protections	Input Current Protection Output Open Circuit Protection Overload Protection Over Temperature Protection Output Short Circuit Protection Output To Ground Short Circuit Protection
Service Life	50,000 hours
Approvals / Class	RoHS , cURus , CEC , Dry or Damp Locations

MECHANICAL DATA

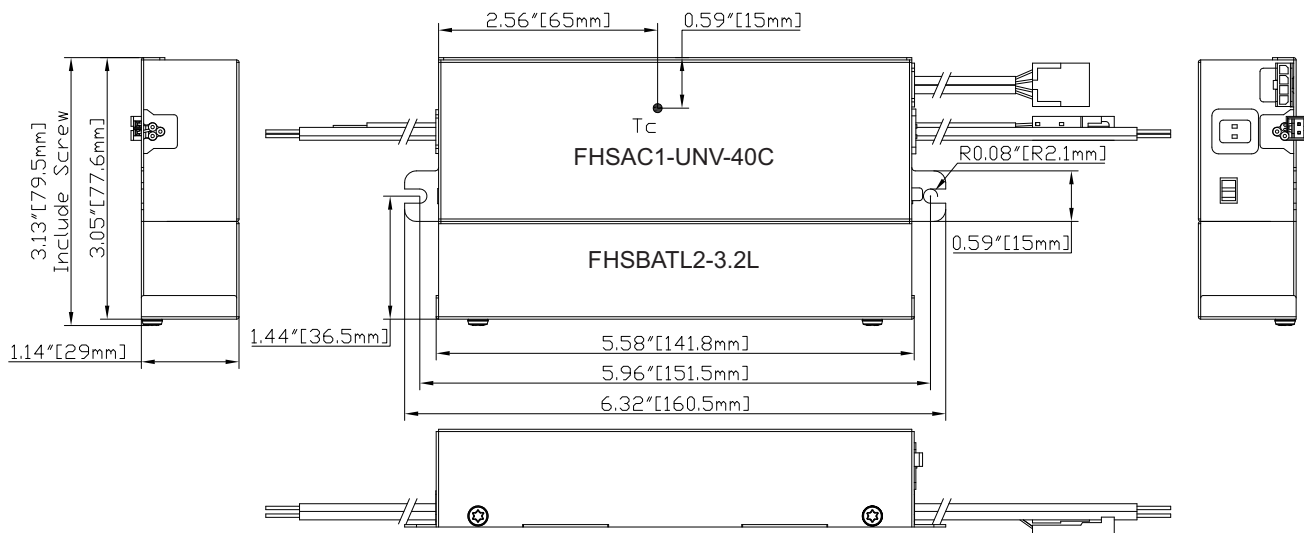

Case Tolerance=±0.02"

Fulham extends a limited warranty to the original purchaser or first user for a period of 5 years @ Tc 63°C from the date of manufacture when properly installed and operated under normal conditions of use. For complete terms and conditions, please refer to the Warranty Center at www.fulham.com. Specifications subject to change without notice.

Accessories

Bi-Color Wet Location Test Switch: FHS-TSTWL-BC

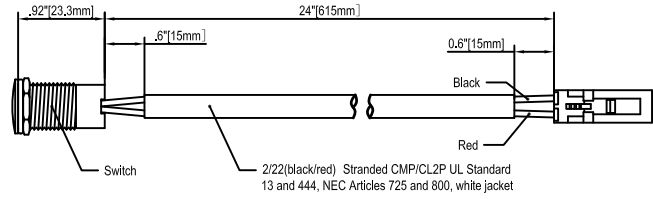

Overall Switch Dimension

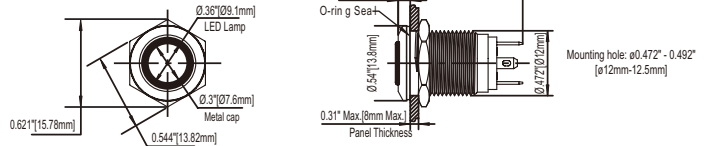

Test Switch Extension: FHS-EXT-48-TST

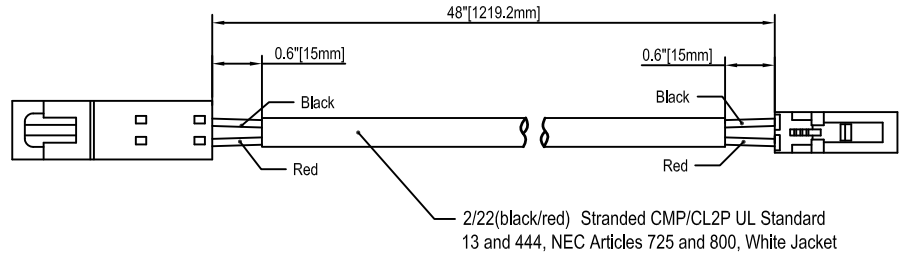

Wall Plate: FHSWLPWH



Wall plate and screw color:
white with black lettering

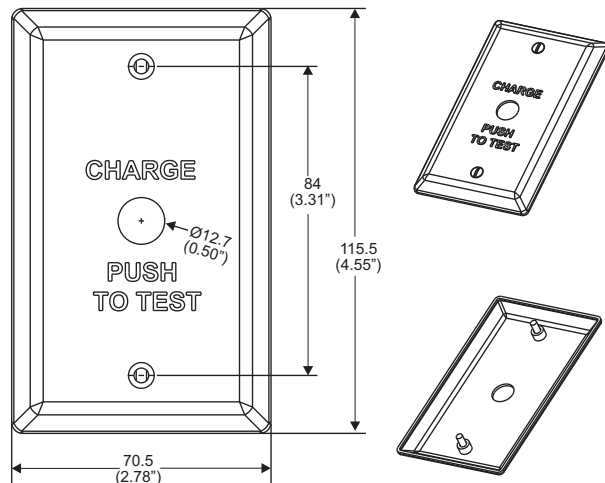

1. "Charge push to Test" plate
2. (2) 6-32 x 1/2" LG mounting screws

Fulham extends a limited warranty to the original purchaser or first user for a period of 5 years @ Tc 63°C from the date of manufacture when properly installed and operated under normal conditions of use. For complete terms and conditions, please refer to the Warranty Center at www.fulham.com. Specifications subject to change without notice.

Figure 1

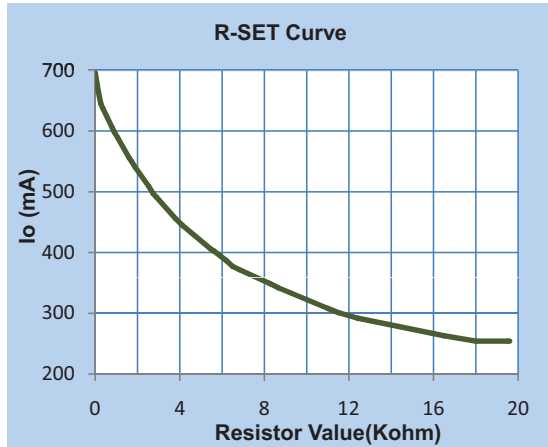

Figure 2

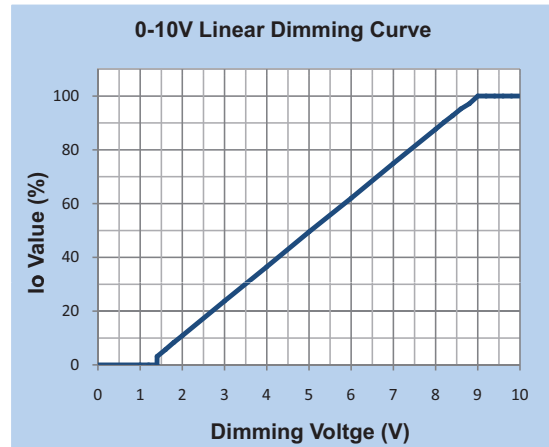

Figure 3

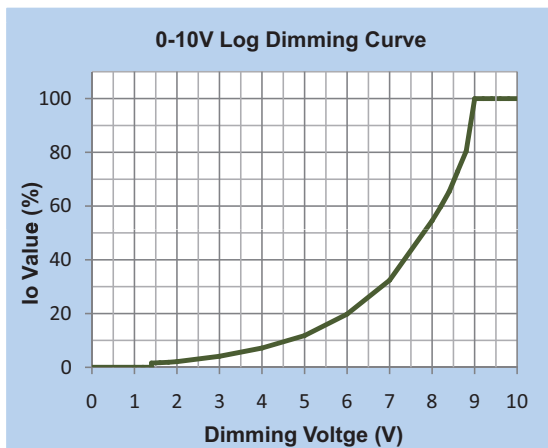

Figure 4

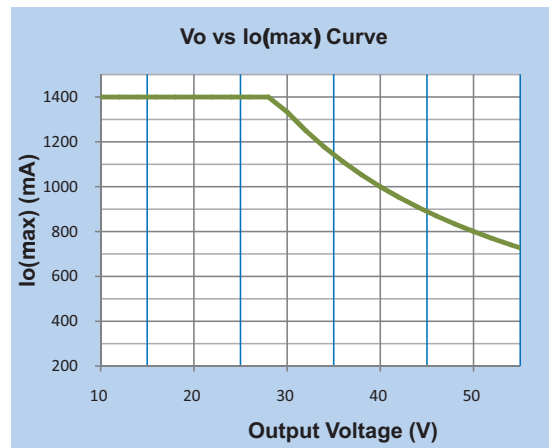

Figure 5

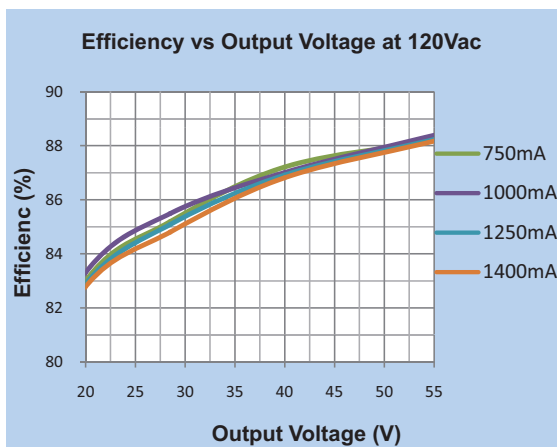
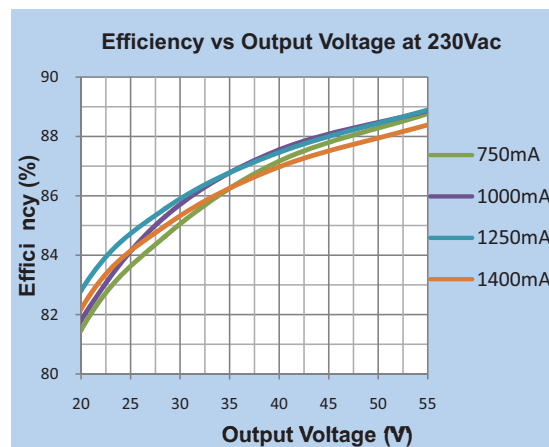

Figure 6



Fulham extends a limited warranty to the original purchaser or first user for a period of 5 years @ Tc 63°C from the date of manufacture when properly installed and operated under normal conditions of use. For complete terms and conditions, please refer to the Warranty Center at www.fulham.com. Specifications subject to change without notice.

Figure 7

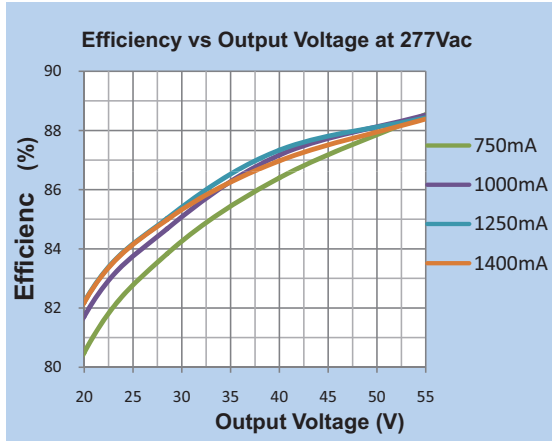

Figure 8

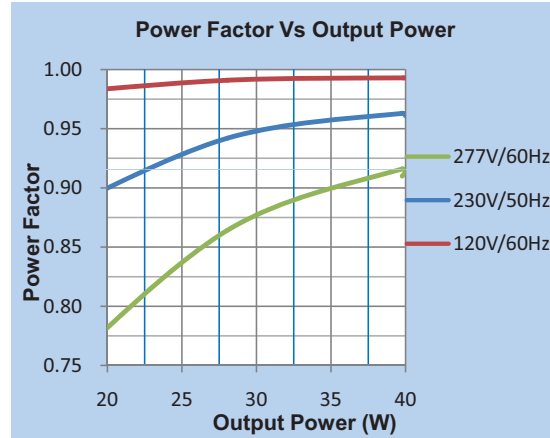

Figure 9

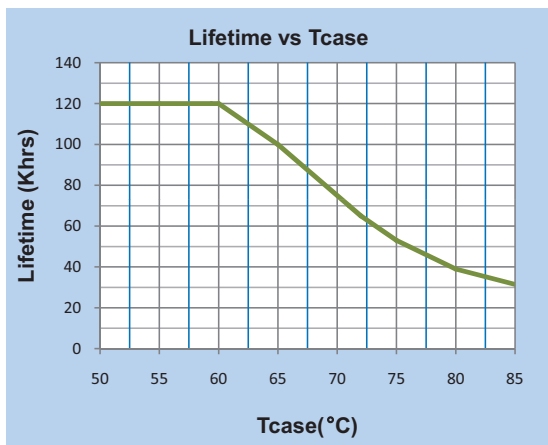

Figure 10

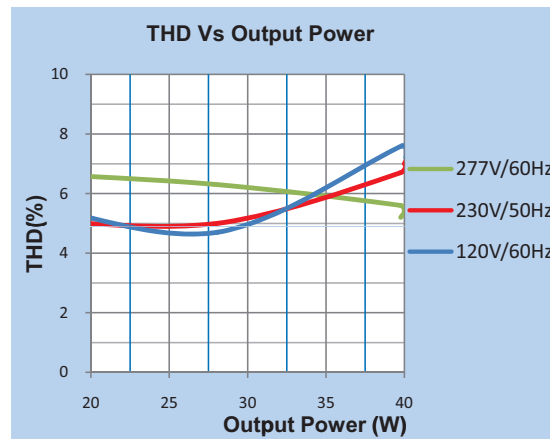

Figure 11

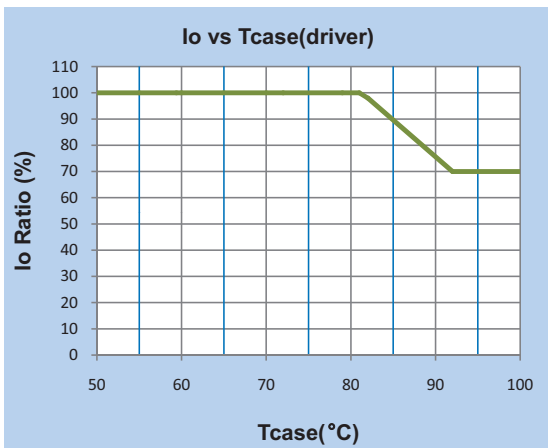
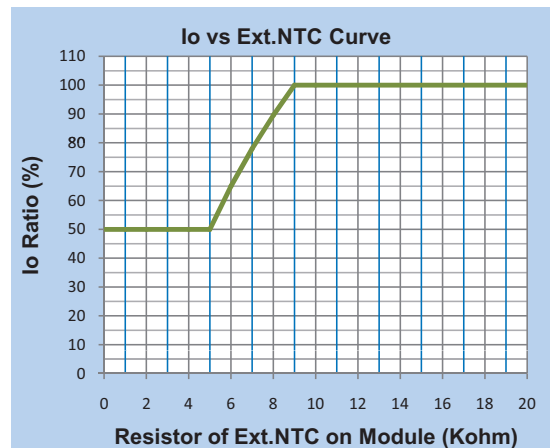
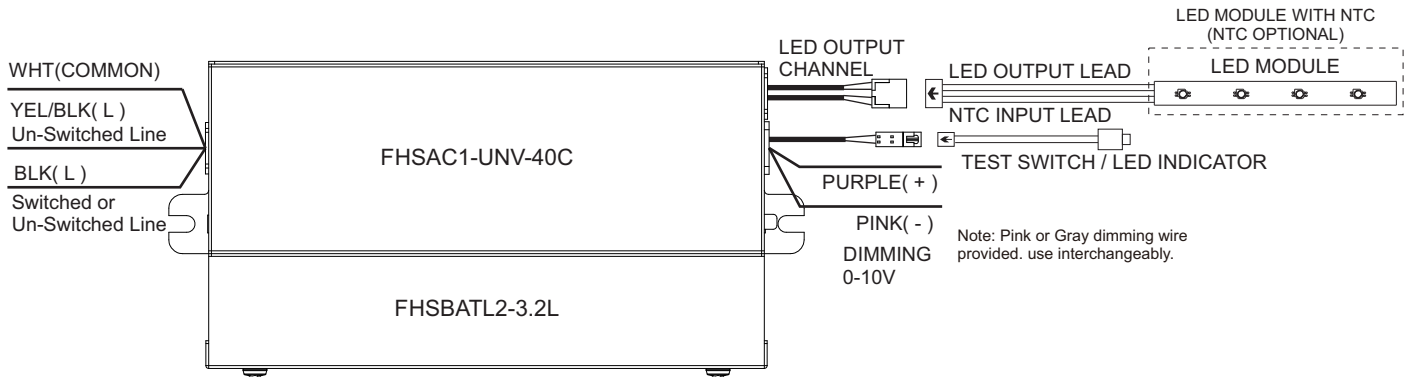

Figure 12



Fulham extends a limited warranty to the original purchaser or first user for a period of 5 years @ Tc 63°C from the date of manufacture when properly installed and operated under normal conditions of use. For complete terms and conditions, please refer to the Warranty Center at www.fulham.com. Specifications subject to change without notice.

WIRING DIAGRAMS



Case	Dimensions
Length	6.32"[160.5mm]
Width	3.05"[77.6mm]
Height	1.14"[29mm]

INPUT SIDE	LENGTH
BLACK	12"[304.8mm]
WHITE	12"[304.8mm]
YEL/BLK	16"[406.4mm]

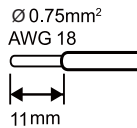

OUTPUT SIDE	LENGTH
LED OUTPUT	8"[203.2mm]
TEST LEAD	8"[203.2mm]
PURPLE	12"[304.8mm]
PINK	12"[304.8mm]

Note: Pink or Gray dimming wire provided. use interchangeably.

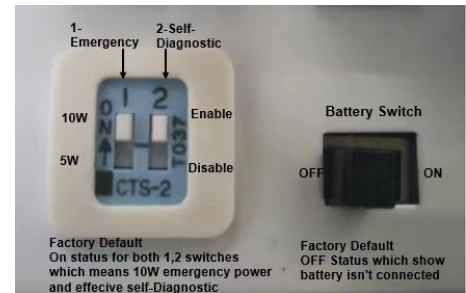

- NOTE:**
- 1.The driver must be grounded.
 - 2.Once assembly, installation or servicing is complete, set the BATTERY SWITCH to the ON position.
 - 3.Factory default setting, battery switch in off status. Emergency power switch is on and self-diagnostic switch is on.

SELF DIAGNOSTIC INSTRUCTIONS / OPERATION:

If Dip Switch 2 (Self-Diagnostic Switch) is set to the OFF position:

The self diagnostic feature is disable. A functionality test shall be manually conducted every thirty (30) days to ensure the emergency LED light source illuminates as intended. A full discharge test shall be conducted once a year; the LED light source shall illuminate for a minimum of ninety (90) minutes for the 10W load (Dip Switch 1 is set to the ON position) or one hundred eighty (180) minutes for 5W load (Dip Switch 1 is set to the OFF position).

If Dip Switch 2 (Self-Diagnostic Switch) is set to the ON position:

The self diagnostic feature is enable .The emergency LED driver will conduct a self check for thirty (30) seconds every thirty (30) days; and ninety (90) minutes or one hundred eighty (180) minutes self check every 12 months. After every self check the LED indicator light will indicate a status signal. A single self-diagnostic test can be activated by pressing the test switch three (3) times. Refer to Indicators Status Table for details.

When user toggle the Dip Switch, the LED indicator on Switch button would flash 3 times, 2.5S ON/0.5S OFF for Enabled, while 0.5S ON/2.5S OFF for Disabled.

EBD (Emergency Battery Disengage)

This unit includes Fulham’s EBD (Emergency Battery Disengage) Feature. The battery can be disconnected temporarily without physically removing it.





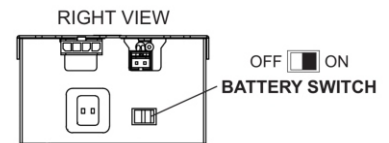



After the EM unit has been installed and tested:

- 1) Battery switch will be set to the “off” position to disable emergency.
- 2) Once the emergency output has been disabled, the switch can now be set to the “on” position before closing the luminaire.
- 3) Alternatively, the test switch can be pressed and held for 5 seconds to turn off the output during emergency mode.



Fulham extends a limited warranty to the original purchaser or first user for a period of 5 years @ Tc 63°C from the date of manufacture when properly installed and operated under normal conditions of use. For complete terms and conditions, please refer to the Warranty Center at www.fulham.com. Specifications subject to change without notice.

TEST SWITCH INDICATOR STATUS:

LED Indicators Status	EM Driver Status / Mode
 Solid Green	System OK / AC OK (Self-Diagnostic Enabled or Disabled)
 Slow Flashing Red, 4s on / 1s off	Battery NOT detected, check battery switch or connection
 Flashing Red, 1s on / 1s off	Battery Failure, replace battery
 Flashing Green, 1s on / 1s off	Self-Diagnostic test underway
 Fast flashing Red, 0.1s on/0.1s off	Abnormal driver performance, replace driver
 Very Slow Flashing Red, 4s on/4s off	Over Temperature Protection
 Fast Flashing Green, 0.1s on/3s off	Normal working in EM mode
 Green/Red alternative flashing 1s green/1s red	No load or output over voltage protection triggered

TEST SWITCH OPERATIONS:

1. EM Test: Press and hold test button (>1s) to enter EM mode for testing in normal AC powered. Subsequent tests can be performed after a minimum 20 Second delay in pressing the Test Switch.
2. Manual Self-Diagnostic(When Self-Diagnostic Enabled - Dip Switch 1 set to the ON position): After charging twelve (12) hours or battery fully charged, quickly press the test button three (3) times within three (3) seconds to force the controller to enter a Self-Diagnostic cycle. To quit the self-diagnostic cycle after engaged press and hold the test button for ten (10) seconds.
3. Emergency Battery Disengage: Press and hold the test switch for 5 seconds during EM output condition to turn off EM output.

Programming:

This driver can be programmed using the TPSB-100(E). Programming features include the following:

- * Output Current: 250-1400mA
- * Dimming Curve
- * LED NTC Thermal Protection



* For more detailed programming instructions please see our Programming Instructions and Design Guide found on our website:

- <https://www.fulham.com/PDFs/SpecSheets/Fulham-Design-Guide-Programmable-Drivers.pdf>

Important Safety Instructions

When using electrical equipment and this lighting device basic safety precaution should be followed at all times including but not limited to the following:

PLEASE READ CAREFULLY AND FOLLOW ALL INSTRUCTIONS FOR YOUR OWN SAFETY

- **IMPORTANT:** An un-switched AC power source of 120VAC to 277VAC is required for the yellow/black and white leads.
- **IMPORTANT:** A switched or un-switched AC power source of 120VAC to 277VAC is acceptable for the black lead only.
- This device is designed for use in fixtures listed for **dry and damp locations**.
- **CAUTION:** Make sure all electrical connections conform to the National Electrical Code and all applicable local regulations.
- **CAUTION:** Do not mount near gas or electric heaters.
- **CAUTION:** Do not use this emergency driver with accessory equipment other than recommended by manufacturer; failure to follow this may cause an unsafe condition. Servicing should only be performed by qualified service personnel.
- **CAUTION:** Do not use this emergency driver for other than intended use.
- **CAUTION:** Battery is rechargeable LiFePO4 type and must be recycled or disposed of properly.
- **CAUTION:** Equipment should be mounted in locations and at heights where it will not readily be subjected to tampering by unauthorized personnel.

ASSEMBLY and FIELD INSTALLATION WIRING: WARNING: AC power must be off before proceeding with assembly, installation or servicing of emergency driver. Additionally ensure that the battery is disengaged according to EBD operation or battery switch is off.

TESTING SYSTEM: The emergency battery requires a minimum charge time of one (1) hour before testing the circuit. A minimum of twelve (12) hours is required for a full charge.

IMPORTANT: In order to maintain proper operation and warranty coverage, the battery must be recharged once per year prior to installation.

RATED EMERGENCY OPERATION: Ninety (90) minutes for the 10W load or one hundred eighty (180) minutes for the 5W load. The 10W or 5W option is determined by the position of Dip Switch 1 (Emergency Power Selection Switch).