



### FEATURES

- Supports DALI-2 + PUSH DIM Control + NFC
- Inbuilt CLO Function
- Compliance to DALI-2 PART 101, 102, 207, 251, 252, 253
- DALI Function setting through NFC
  - a. O/P Current setting in step of 1mA.
  - b. Set Min-Max level.
  - c. Set system failure level.
  - d. Set power on level.
  - e. Set address manually 0 to 63.
  - f. Create Groups manually 1 to 16.
  - g. Set Fade time.
  - h. Set fade rate.
  - i. change dimming curve manually Linear OR Logarithmic.
  - j. Set Scenes manually.
- SELV CLASS II Design.
- Dimming range 0.1% to 100%.
- High PF, Low THD, High Efficiency.
- CE, Flicker free.
- Nominal Life 100,000hrs.
- Suitable for indoor use only.

### INTERFACE

- DALI-2 DT6
- PUSH-DIM

### FUNCTIONS

- Memory function
- Suitable for emergency lighting (EL)
- Protection features  
(short circuit, open circuit, over load, no load, hot plug-in)

### SUITABLE FOR LIGHTS

- Suitable for Linear lights, tri-proof lights, working lights and other linear or ultra thin lights.

### TYPICAL APPLICATIONS

- LED Indoor lighting.
- LED Office lighting.
- LED Commercial lighting.

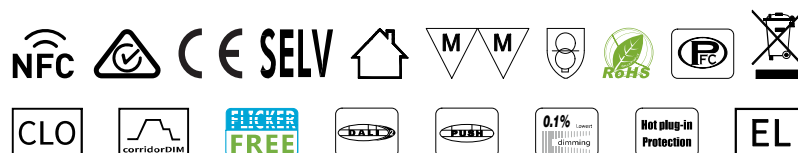

- Dimmable Constant Current 1-Channel LED Driver with DALI DT6
- Dimming range 0.1 to 100%
- NFC Programable
- DALI PART 101, 102, 207, 251, 252 & 253
- Inbuilt CLO Function
- Output Wattage : 10W Max
- Output voltage range of 3-42Vdc
- Output Current: 100 - 450mA
- Flicker-free Output ripple current <5% LF

- Application**
- LED indoor lighting
  - LED office lighting
  - LED architectural lighting
  - LED panel lamp lighting

## General Specifications

Rated Input Voltage	240VAC ±10%, 50/60Hz	
Operating Input Voltage Range	196-264VAC, 50/60Hz	
Input Current Max.	0.1 @ 230Vac	
Input Power	14.5W	
Power Factor	>0.9 @ 230Vac Full Load	
THD	<15% @ 230Vac Full Load	
Efficiency (Typical)	70%	
Driver Type	Constant Current DALI-2	
Output Current	100mA to 450mA ±3% (Current setting through NFC, with step of 0.1mA)	
	<b>Default Current setting 250mA</b>	
	*Refer Output Voltage vs Output current graph	
Output Voltage Range	3-42Vdc	
Dimming Controller Type	DALI-2 (Amplitude/CCR dimming)	
Output Power	10W	
Output ripple current	<5%, Flicker Free at 100Hz	
Number of Output Channels	1 Channel	
Output Type	Class II	
Ambient Operating Temperature Range	-20°C to 45°C	
Max. Case Temperature	85°C	
Input Surge Protection	2KV	
Protections	Input Over Current	: Non Resettable (Fuse)
	Output Short Circuit	: Auto Recovery (HICCUP Mode)
	Output Open Circuit	: Auto Recovery (HICCUP Mode)
	Output Overload	: YES
	Over Temperature	: Auto Recovery (HICCUP Mode)
Standards	EN55015, EN61000-3-2, EN61000-3-3	
	EN61547, EN61000-4-2,3,4,5,6,8,11	
	EN61347-1, EN61347-2-13	
	IEEE1789	
Withstand Voltage	I/P-O/P:3750Vac	
Leakage Current	<0.5mA @ 240Vac	
Isolation resistance	I/P-O/P:100MΩ / 500Vdc / 25°C / 70% RH	
Life	50,000 Hours @ 80°C	
Approvals / Class	SELV Equivalent	
Warranty	5 Years at Tc 80°C	
Weight	0.07 Kg	

Note : Suitable for indoor application only

Fulham extends a limited warranty only to the original purchaser or to the first user for a period of **05 years @ Tc 80°C** from the date of manufacture when properly installed and operated under normal conditions of use. For complete terms and conditions, please reference the Fulham Product Catalog ([www.fulham.com](http://www.fulham.com)). Due to a program of continuous improvement, Fulham reserves the right to make modifications or variations in design or construction to the equipment described. © Fulham Company Limited, All Rights Reserved.

### Output Voltage Vs Output Current

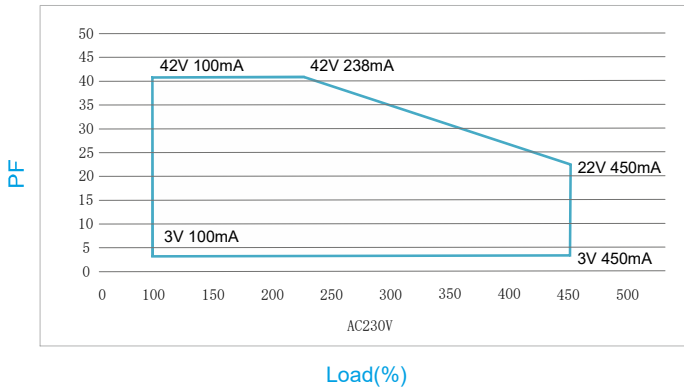

### THD vs. Load

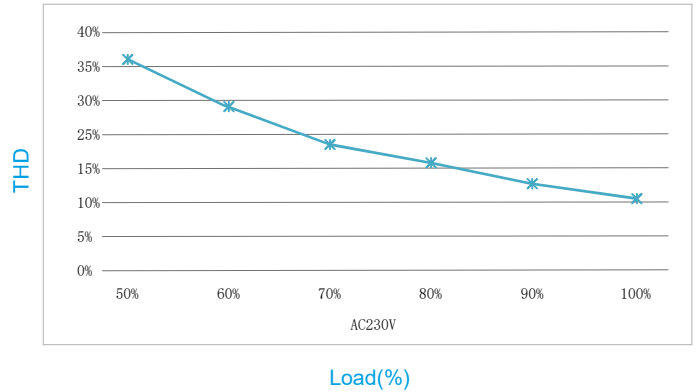

\* Default Current - 250mA

### Power factor vs. Load

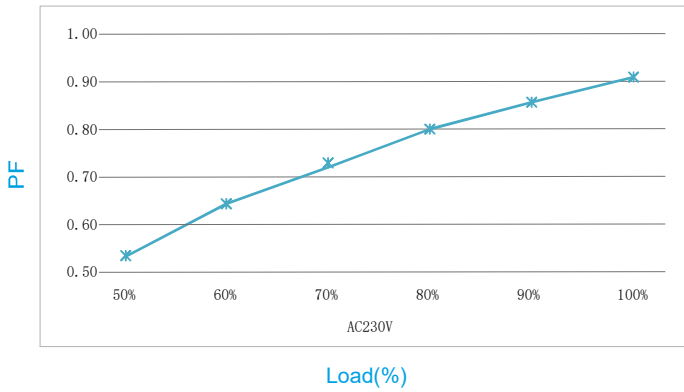

### Efficiency vs load

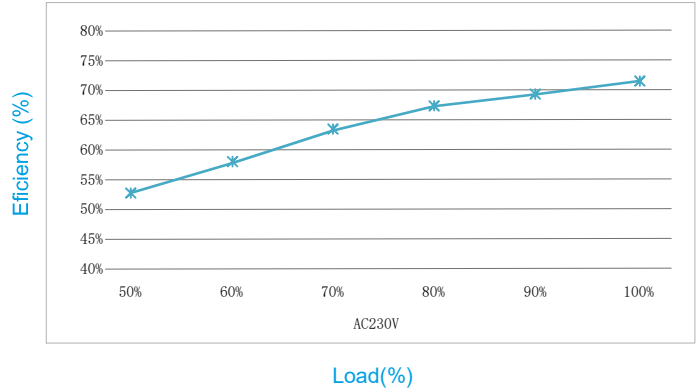

### Life vs. Tc curve

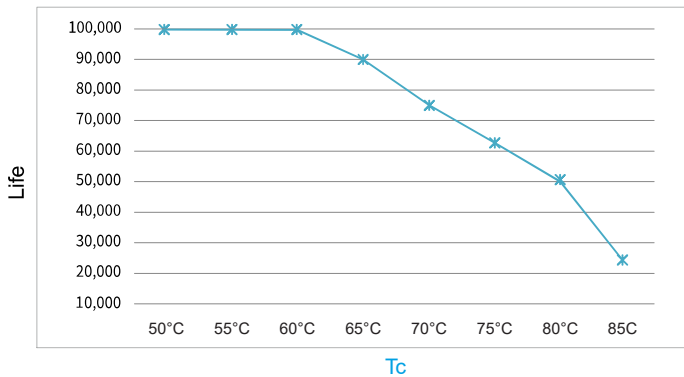

### Dimming Curve

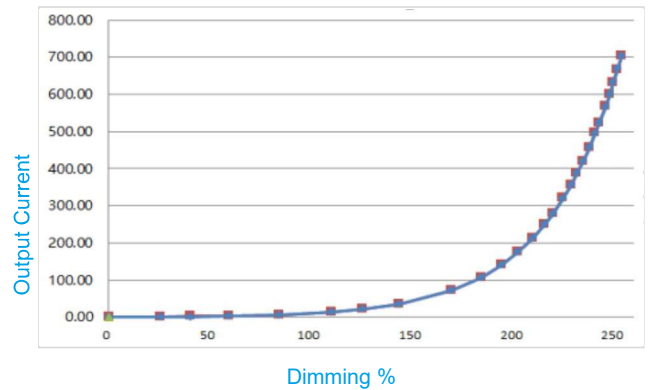

Remarks: The default is logarithmic dimming curve.

Fulham extends a limited warranty only to the original purchaser or to the first user for a period of **05 years @ Tc 80°C** from the date of manufacture when properly installed and operated under normal conditions of use. For complete terms and conditions, please reference the Fulham Product Catalog ([www.fulham.com](http://www.fulham.com)). Due to a program of continuous improvement, Fulham reserves the right to make modifications or variations in design or construction to the equipment described. © Fulham Company Limited, All Rights Reserved.

### DALI dimming application

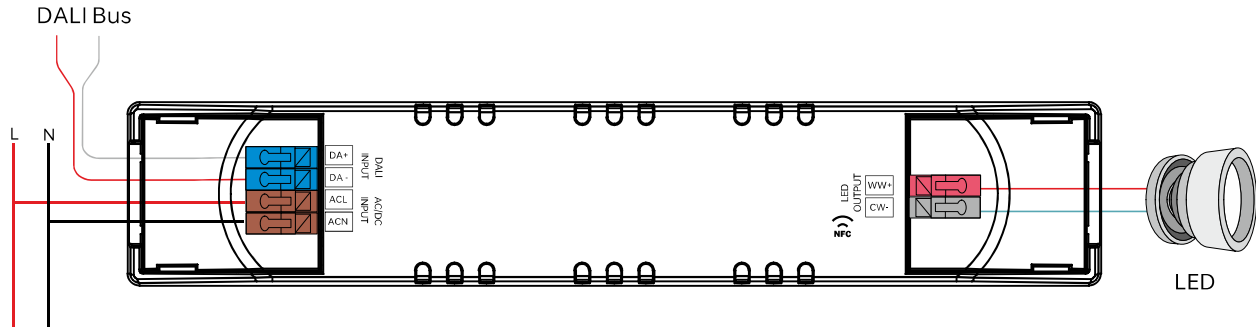

### Activating DALI control mode

- After installation according to the wiring diagram of DALI control application, the driver will automatically switch to the DALI control mode after receiving any DALI command.

### PUSH dimm

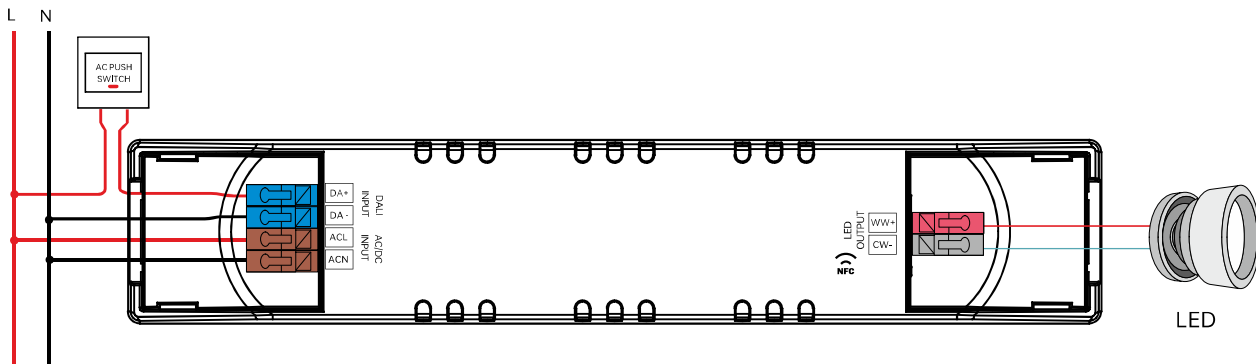

### Using PUSH DIM controls:

After installation according to the wiring diagram of PUSH-DIM control application,

1. Press PUSH switch it will increase the Brightness, release the witch and again press PUSH switch it will Reduce the Brightness.

### Multiple lights synchronize control operation

method 1: Step 1: long press the PUSH-DIM switch, confirm each light is on.

Step 2: short press the PUSH-DIM switch, confirm each light is off.

Step 3: long press the PUSH-DIM switch, confirm each light is from darkest to brightest and all the lights are synchronous.

method 2: - Long press the PUSH-DIM dimming switch for more than 15s, all drivers will output 100% brightness and the color temperature is natural white (middle of color temperature range).

### Remarks:

- Standard DALI control line voltage range: 9.5V to 22.5V, type 16V.
- The two DALI control lines polarity-reversible.
- Max. 64 DALI drivers per DALI control line.
- The maximum distance length of the DALI control line is 300m at 2x1.5mm<sup>2</sup>.
- DALI bus can be wired together with any mains voltage cables, but separate wiring is recommended.

### Wiring distance vs cable size

Cable size	Distance
2x0.50mm <sup>2</sup>	max.100m
2x0.75mm <sup>2</sup>	max.150m
2x1.00mm <sup>2</sup>	max.200m
≥2x1.50mm <sup>2</sup>	max.300m

Fulham extends a limited warranty only to the original purchaser or to the first user for a period of **05 years @ Tc 80°C** from the date of manufacture when properly installed and operated under normal conditions of use. For complete terms and conditions, please reference the Fulham Product Catalog ([www.fulham.com](http://www.fulham.com)). Due to a program of continuous improvement, Fulham reserves the right to make modifications or variations in design or construction to the equipment described. © Fulham Company Limited, All Rights Reserved.

**Mechanical Data :**

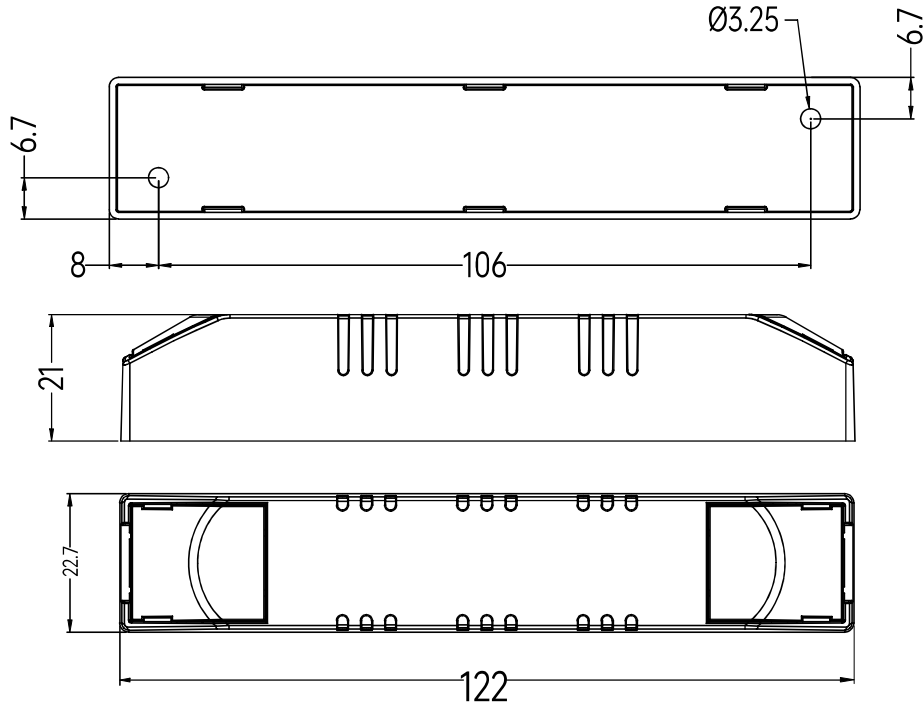

Note : All Dimensions are in mm.

Tolerance=±0.5mm

**Packaging**

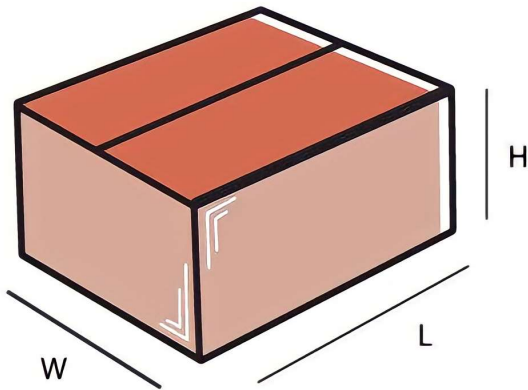

Master carton

OUTER DIMENSION		
L	W	H
Net Weight	Gross Weight	QUANTITY

**Installation Instructions:**

Connect Wires as per details given on the Driver Screen. Keep proper ventilation around the LED Driver and do not stack any object on it. Also a 10-15 cm clearance must be kept when the adjacent device is a heat source. Do not exceed the declared Hot spot temperature(Tc max) under any circumstances.

Fulham extends a limited warranty only to the original purchaser or to the first user for a period of **05 years @ Tc 80°C** from the date of manufacture when properly installed and operated under normal conditions of use. For complete terms and conditions, please reference the Fulham Product Catalog ([www.fulham.com](http://www.fulham.com)). Due to a program of continuous improvement, Fulham reserves the right to make modifications or variations in design or construction to the equipment described. © Fulham Company Limited, All Rights Reserved.