

FEATURES

- Supports DALI-2 + PUSH DIM + PUSH CCT Control + NFC
- Inbuilt CLO Function
- Compliance to DALI-2 PART 101, 102, 207, 209, 251, 252, 253
- DALI Function setting through NFC
 - a. O/P Current setting in step of 1mA.
 - b. Set Min-Max level.
 - c. Set system failure level.
 - d. Set power on level.
 - e. Set address manually 0 to 63.
 - f. Create Groups manually 1 to 16.
 - g. Set Fade time.
 - h. Set fade rate.
 - i. change dimming curve manually Linear OR Logarithmic.
 - j. Set Scenes manually.
- SELV CLASS II Design.
- Dimming range 0.1% to 100%.
- High PF, Low THD, High Efficiency.
- CE, Flicker free.
- Nominal Life 100,000hrs.
- Suitable for indoor use only.

INTERFACE

- DALI-2 DT8
- PUSH-DIM
- PUSH-CCT

FUNCTIONS

- Memory function
- Suitable for emergency lighting (EL)
- Protection features
(short circuit, open circuit, over load, no load, hot plug-in)

SUITABLE FOR LIGHTS

- Suitable for Linear lights, tri-proof lights, working lights and other linear or ultra thin lights.

TYPICAL APPLICATIONS

- LED Indoor lighting.
- LED Office lighting.
- LED Commercial lighting.

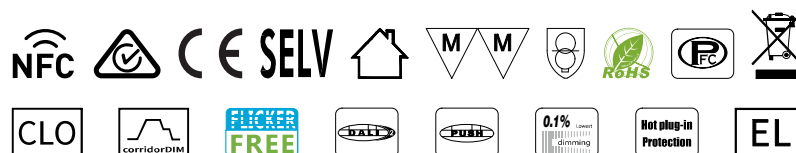

- Dimmable Constant Current 2-Channel LED Driver with DALI DT8
- Support DALI dimming function
- Dimming range 0.1 to 100%
- NFC Programable
- DALI PART 101, 102, 207, 209, 251, 252 & 253
- Inbuilt CLO Function
- Output Wattage : 25W Max
- Output voltage range of 6-53Vdc
- Output Current: 250 - 700mA
- Flicker-free Output ripple current <5% LF
- Application
 - LED indoor lighting
 - LED office lighting
 - LED architectural lighting
 - LED panel lamp lighting

General Specifications

Rated Input Voltage	240VAC ±10%, 50/60Hz
Operating Input Voltage Range	196-264VAC, 50/60Hz
Input Current Max.	0.20 @ 230Vac
Input Power	29W
Power Factor	>0.92 @ 230Vac Full Load
THD	<10% @ 230Vac Full Load
Efficiency	80%
Driver Type	Constant Current DALI-2
Output Current	250mA to 700mA ±3% (Current setting through NFC, with step of 0.1mA)
	Default Current setting 500mA
	*Refer Voltage vs O/P current graph
Output Voltage Range	6-54Vdc
Dimming Controller Type	DALI-2
Output Power	25W
Output ripple current	<5%, Flicker Free at 100Hz
Number of Output Channels	2 Channel
Output Type	Class II
Ambient Operating Temperature Range	-20°C to 45°C
Max. Case Temperature	85°C
Input Surge Protection	2KV
Protections	Input Over Current : Non Resettable (Fuse) Output Short Circuit : Auto Recovery (HICCUP Mode) Output Open Circuit : Auto Recovery (HICCUP Mode) Output Overload : YES Over Temperature : Auto Recovery (HICCUP Mode)
Standards	EN55015, EN61000-3-2, EN61000-3-3 EN61547, EN61000-4-2,3,4,5,6,8,11 EN61347-1, EN61347-2-13 IEEE1789
Withstand Voltage	I/P-O/P:3750Vac, I/P-FG:1750Vac, O/P-FG:500Vac, I/P-DALI:500Vac
Leakage Current	<0.5mA @ 240Vac
Isolation resistance	I/P-O/P:100MΩ / 500Vdc / 25°C / 70% RH
Life	50,000 Hours @ 80°C
Approvals / Class	SELV Equivalent
Warranty	5 Years at Tc 80°C
Weight	0.122 Kg

Note : Suitable for indoor application only

Fulham extends a limited warranty only to the original purchaser or to the first user for a period of **05 years @ Tc 80°C** from the date of manufacture when properly installed and operated under normal conditions of use. For complete terms and conditions, please reference the Fulham Product Catalog (www.fulham.com). Due to a program of continuous improvement, Fulham reserves the right to make modifications or variations in design or construction to the equipment described. © Fulham Company Limited, All Rights Reserved.

Output Voltage Vs Output Current

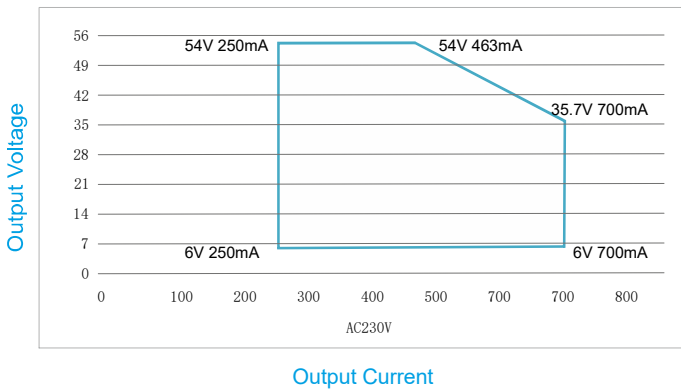

* Default Current - 500mA

THD vs. Load

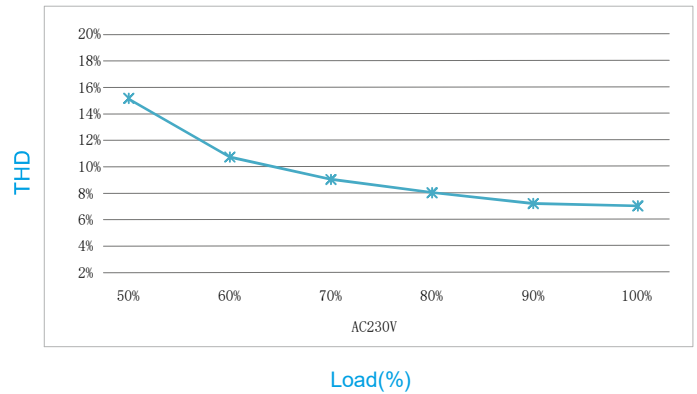

Power factor vs. Load

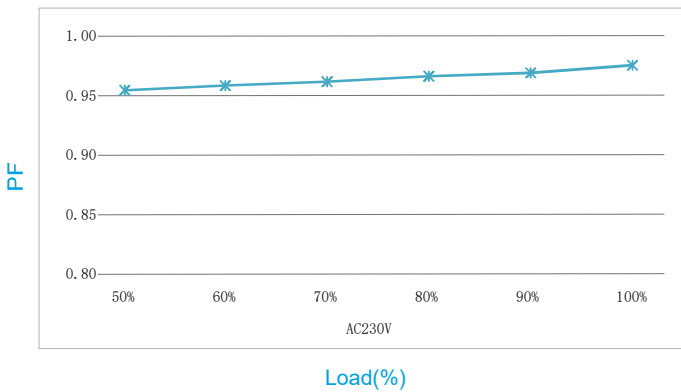

Efficiency vs load

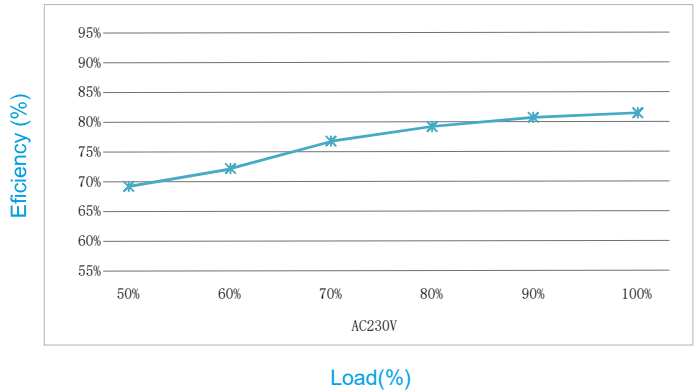

Life vs. Tc curve

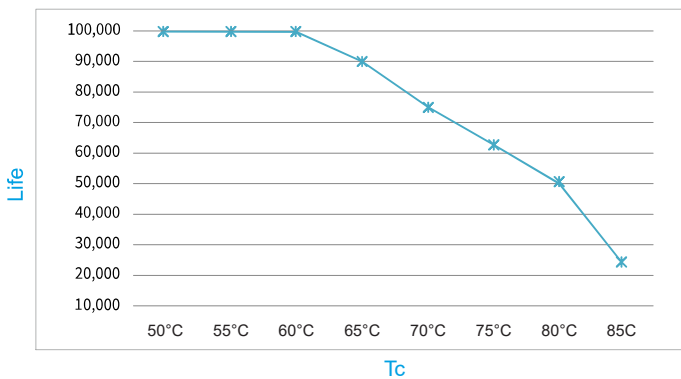

Dimming Curve

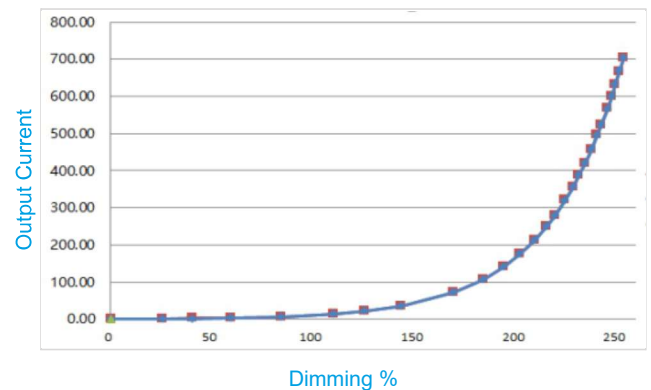

Remarks: The default is logarithmic dimming curve.

Fulham extends a limited warranty only to the original purchaser or to the first user for a period of **05 years @ Tc 82°C** from the date of manufacture when properly installed and operated under normal conditions of use. For complete terms and conditions, please reference the Fulham Product Catalog (www.fulham.com). Due to a program of continuous improvement, Fulham reserves the right to make modifications or variations in design or construction to the equipment described. © Fulham Company Limited, All Rights Reserved.

DALI dimming application

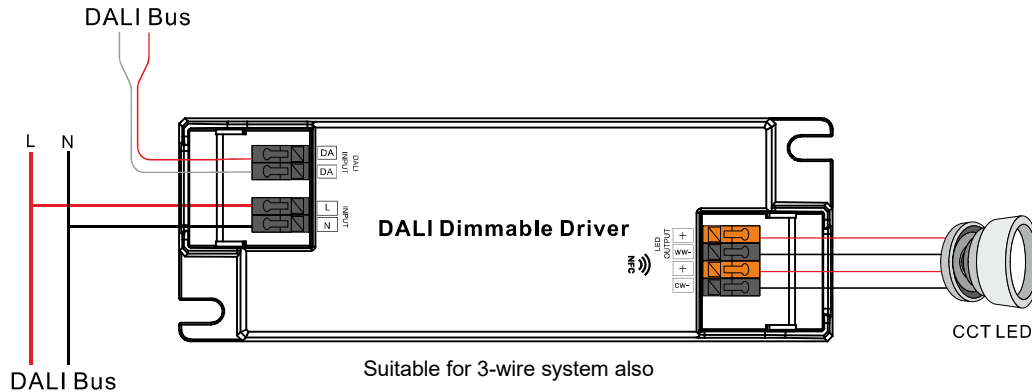

Activating DALI control mode

- After installation according to the wiring diagram of DALI control application, the driver will automatically switch to the DALI control mode after receiving any DALI command.

PUSH DIM & PUSH CCT

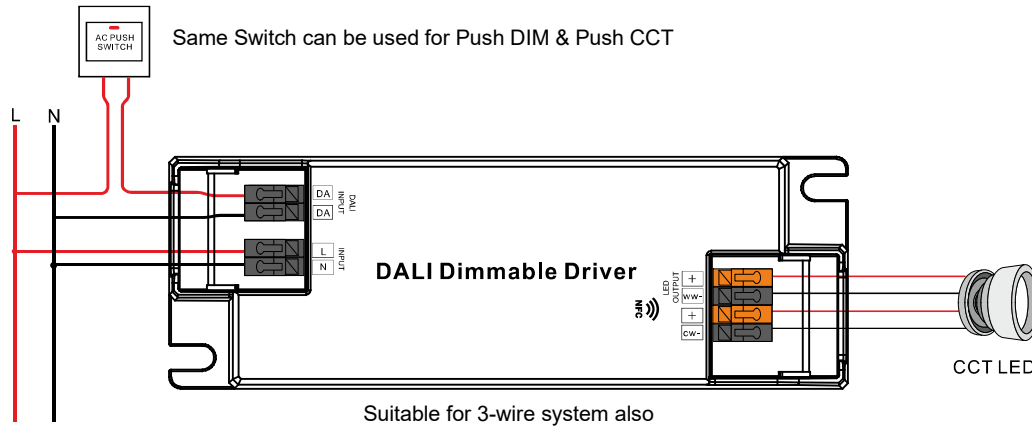

Using PUSH DIM controls:

After installation according to the wiring diagram of PUSH-DIM control application,

1. Press PUSH switch it will increase the Brightness, release the witch and again press PUSH switch it will Reduce the Brightness.

Multiple lights synchronize control operation

- method 1:
- Step 1: long press the PUSH-DIM switch, confirm each light is on.
 - Step 2: short press the PUSH-DIM switch, confirm each light is off.
 - Step 3: long press the PUSH-DIM switch, confirm each light is from darkest to brightest and all the lights are synchronous.
- method 2:
- Long press the PUSH-DIM dimming switch for more than 15s, all drivers will output 100% brightness and the color temperature is natural white (middle of color temperature range).

Remarks:

- Standard DALI control line voltage range: 9.5V to 22.5V, type 16V.
- The two DALI control lines polarity-reversible.
- Max. 64 DALI drivers per DALI control line.
- The maximum distance length of the DALI control line is 300m at $2 \times 1.5\text{mm}^2$.
- DALI bus can be wired together with any mains voltage cables, but separate wiring is recommended.

Wiring distance vs cable size

Cable size	Distance
$2 \times 0.50\text{mm}^2$	max.100m
$2 \times 0.75\text{mm}^2$	max.150m
$2 \times 1.00\text{mm}^2$	max.200m
$\geq 2 \times 1.50\text{mm}^2$	max.300m

Fulham extends a limited warranty only to the original purchaser or to the first user for a period of **05 years @ Tc 80°C** from the date of manufacture when properly installed and operated under normal conditions of use. For complete terms and conditions, please reference the Fulham Product Catalog (www.fulham.com). Due to a program of continuous improvement, Fulham reserves the right to make modifications or variations in design or construction to the equipment described. © Fulham Company Limited, All Rights Reserved.

Mechanical Data :

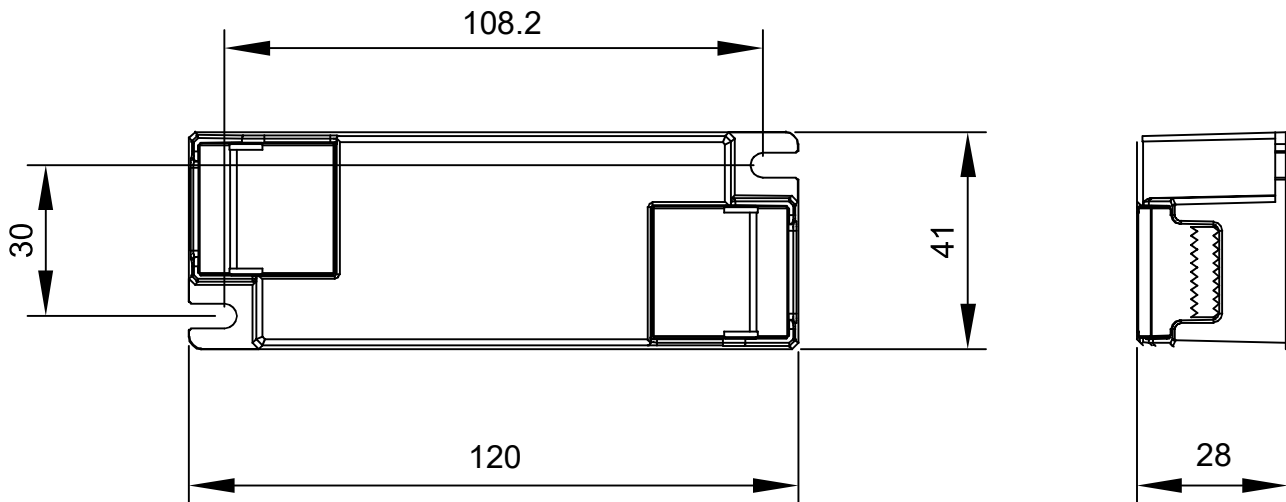

Note : All Dimensions are in mm.

Tolerance=±0.5mm

Packaging

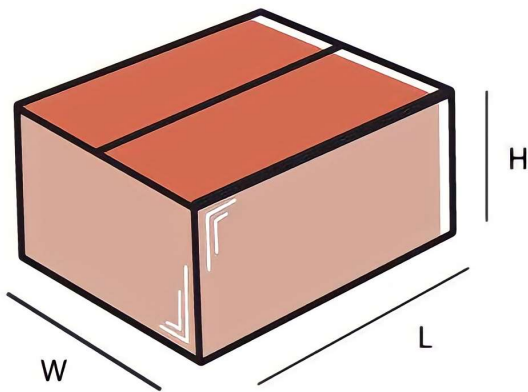

Master carton

OUTER DIMENSION		
L	W	H
250mm	220mm	100mm
Net Weight	Gross Weight	QUANTITY
3.60 kg	4.10kg	30 pc.

Installation Instructions:

Connect Wires as per details given on the Driver Screen. Keep proper ventilation around the LED Driver and do not stack any object on it. Also a 10-15 cm clearance must be kept when the adjacent device is a heat source. Do not exceed the declared Hot spot temperature(Tc max) under any circumstances.

Fulham extends a limited warranty only to the original purchaser or to the first user for a period of **05 years @ Tc 80°C** from the date of manufacture when properly installed and operated under normal conditions of use. For complete terms and conditions, please reference the Fulham Product Catalog (www.fulham.com). Due to a program of continuous improvement, Fulham reserves the right to make modifications or variations in design or construction to the equipment described. © Fulham Company Limited, All Rights Reserved.