

- **SLIM Constant Voltage LED Driver**
- **Flicker free, O/P Ripple Current < 10%**
- **Output Wattage : 120W Max**
- **Output Current: 5.00A**
- **Output voltage 24Vdc**
- **Application**  
- CV indoor Lights

### General Specifications

Rated Input Voltage	240VAC $\pm$ 10%, 50/60Hz
Operating Input Voltage Range	196-264VAC, 50/60Hz
Input Current	0.80 A Max.
Input Power	133W Max.
Power Factor	>0.95 @ 230Vac Full Load
THD	< 10% @ 230Vac Full Load
Efficiency	>88%
Driver Type	Constant Voltage
Output Current	5.00A
Output Voltage Range	24VDC $\pm$ 5%
Output Power	120W
Number of Output Channels	1 Channel
Dimming Controller Type/Dimming Range	NA
RFI/EMI	CE
Output Type	Class II
Ambient Operating Temperature Range	-20°C to 45°C
Max. Case Temperature	85°C
Sound Rating	NA
Input Surge Protection	Line-Neutral 1kV
Protections	Input Over Current : NON-Resettable Input Over Voltage : NA Input Under Voltage : NA Output Short Circuit : Auto recovery Output Open Circuit : Auto recovery Output Overload : YES Over Temperature : YES
Service Life	50,000 hours @ Tc 85°C
Approvals / Class	Dry Locations
Warranty	3 Years
Weight	0.220Kg

Fulham extends a limited warranty only to the original purchaser or to the first user for a period of 3 years @ Tc 85°C from the date of manufacture when properly installed and operated under normal conditions of use. For complete terms and conditions, please reference the Fulham Product Catalog ([www.fulham.com](http://www.fulham.com)). Due to a program of continuous improvement, Fulham reserves the right to make modifications or variations in design or construction to the equipment described. © Fulham Company Limited, All Rights Reserved.

### THD vs. Load

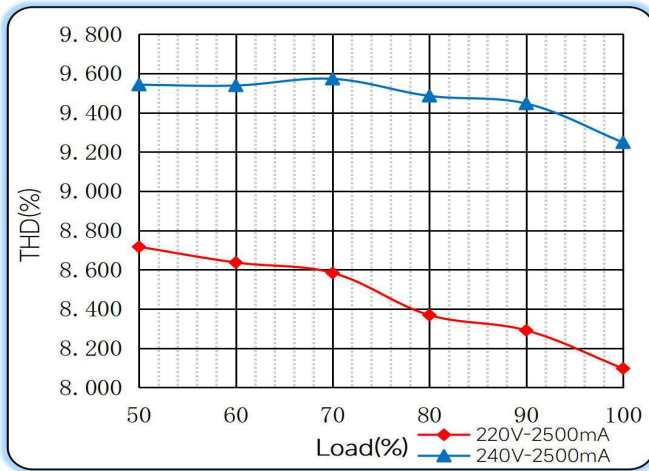

### Efficiency vs. Load

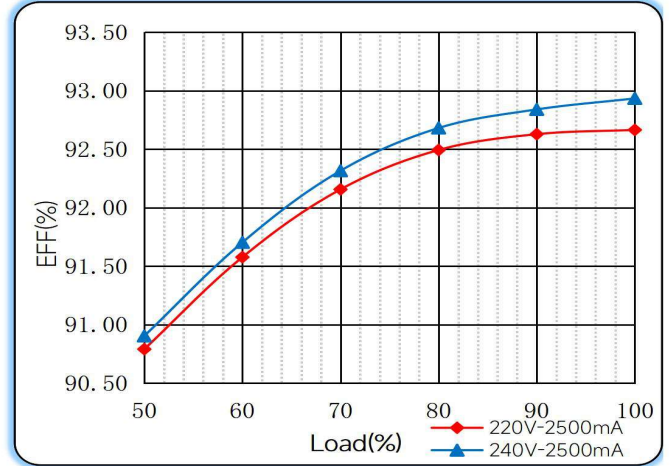

### Power Factor Characteristics

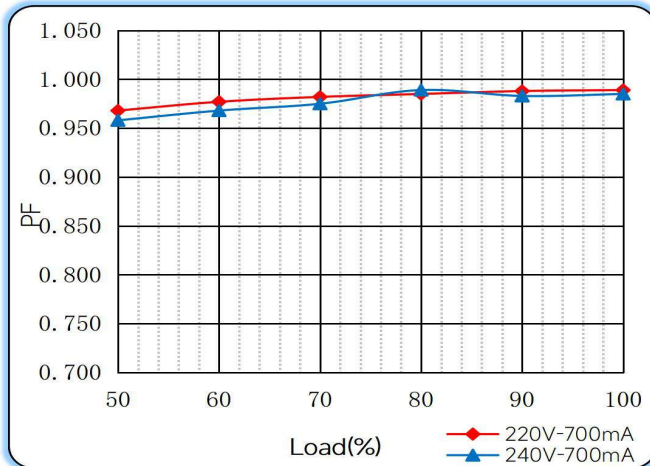

### Lifetime vs. Temperature Curve

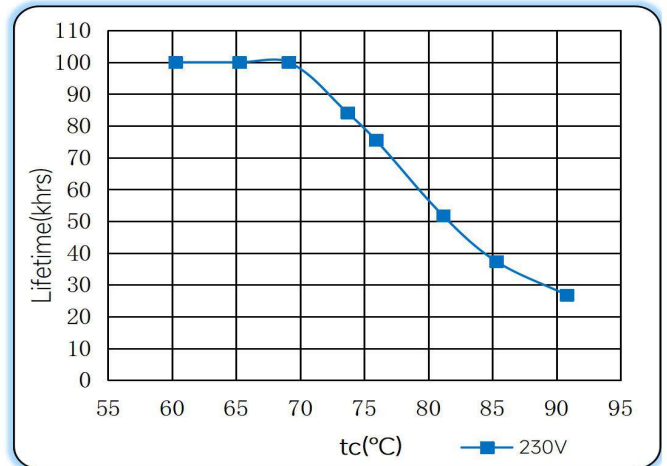

### Operating window

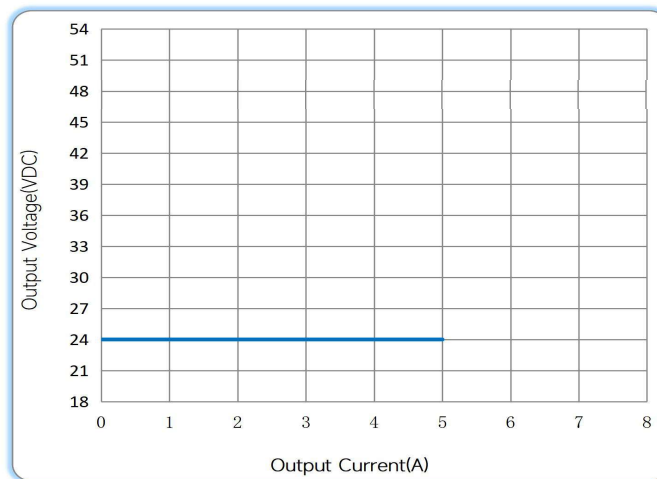

Fulham extends a limited warranty only to the original purchaser or to the first user for a period of 3 years @ Tc 85°C from the date of manufacture when properly installed and operated under normal conditions of use. For complete terms and conditions, please reference the Fulham Product Catalog ([www.fulham.com](http://www.fulham.com)). Due to a program of continuous improvement, Fulham reserves the right to make modifications or variations in design or construction to the equipment described. © Fulham Company Limited, All Rights Reserved.

**Mechanical Data**

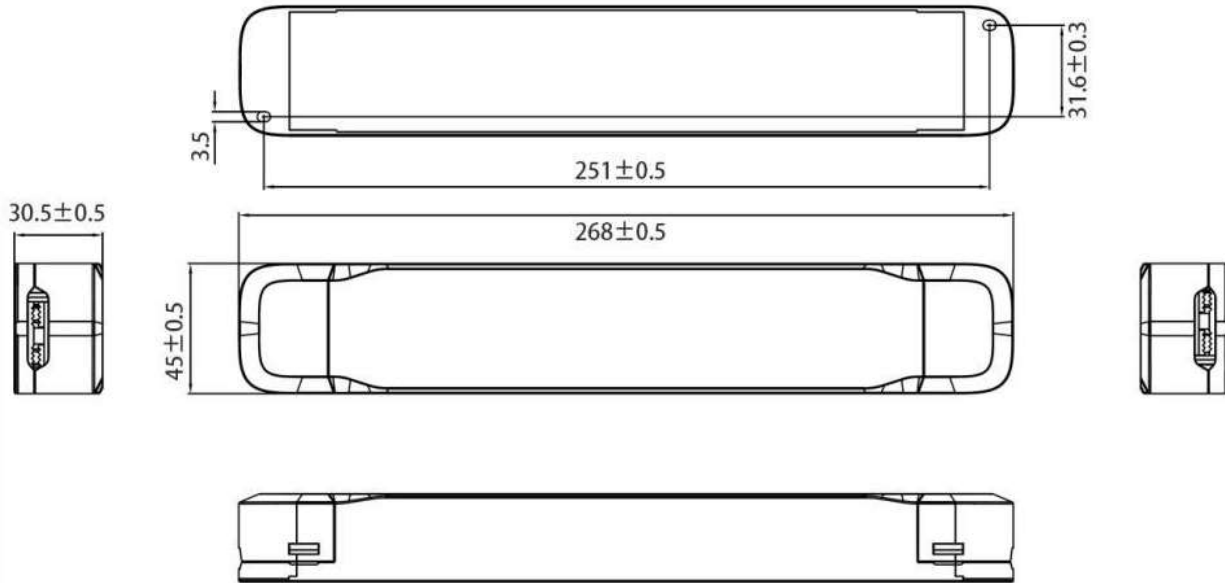

**Product Image**



Note : All Dimensions are in mm.

Tolerance=±0.5mm

**Packaging**

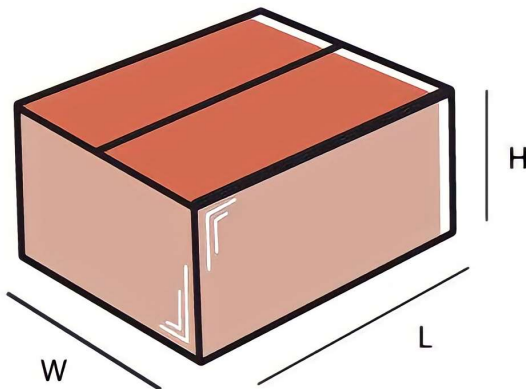

**Master carton**

OUTER DIMENSION		
L	W	H
Net Weight	Gross Weight	QUANTITY

Fulham extends a limited warranty only to the original purchaser or to the first user for a period of 3 years @ Tc 85°C from the date of manufacture when properly installed and operated under normal conditions of use. For complete terms and conditions, please reference the Fulham Product Catalog ([www.fulham.com](http://www.fulham.com)). Due to a program of continuous improvement, Fulham reserves the right to make modifications or variations in design or construction to the equipment described. © Fulham Company Limited, All Rights Reserved.