



Figure 1

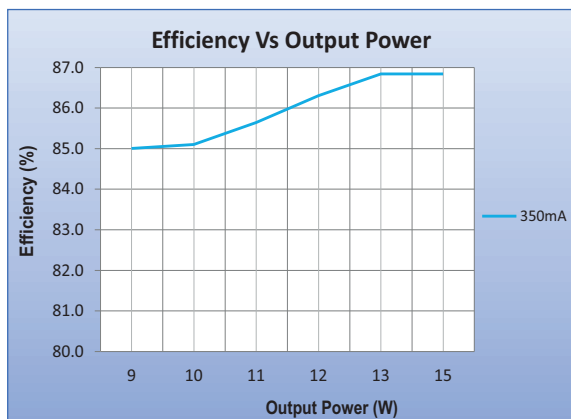

Figure 2

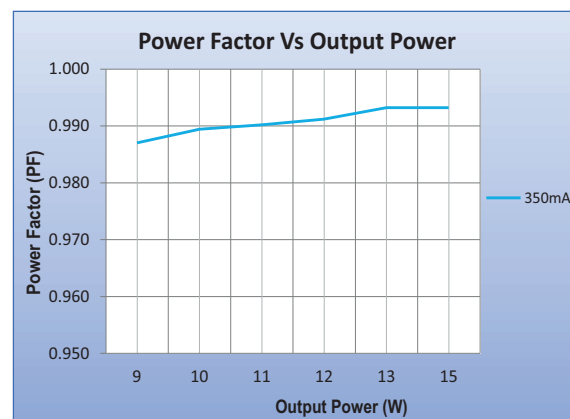

Figure 3

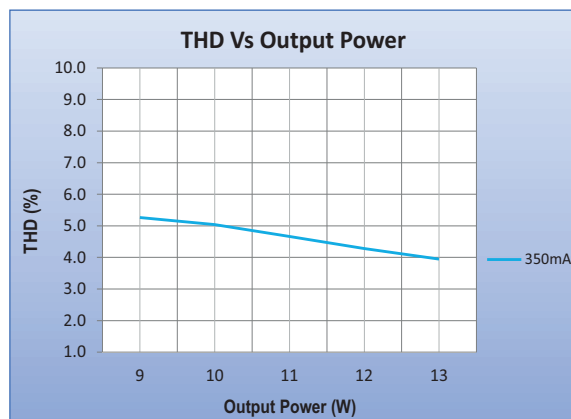

Figure 4

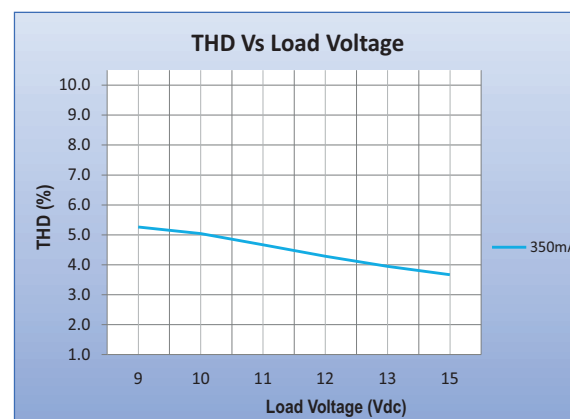
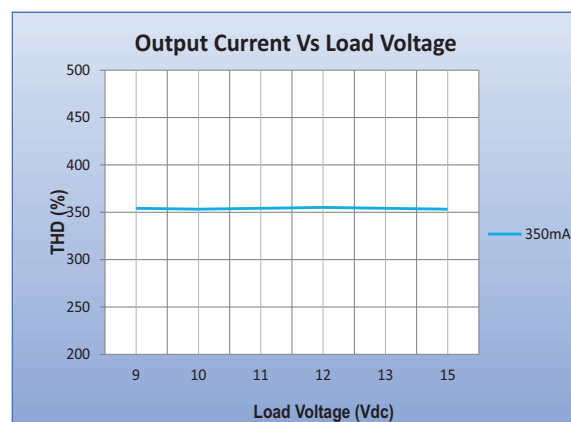
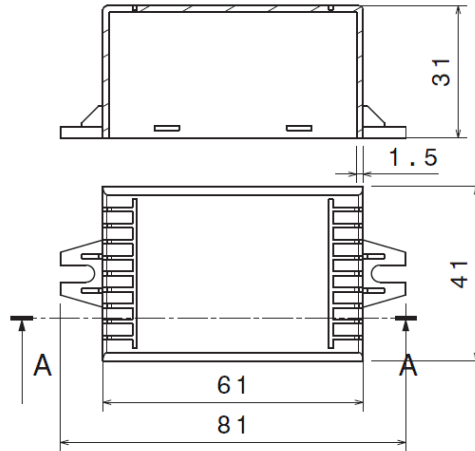

Figure 5



Mechanical Data



Product Image



Note :All Dimensions are in mm .

Tolerance = ± 0.5mm

Wiring Diagrams

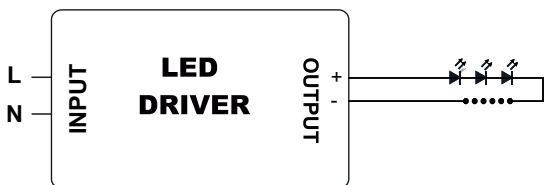

INPUT SIDE	LENGTH
BLACK	250 MM
WHITE	250 MM

OUTPUT SIDE	LENGTH
BLUE	250 MM
RED	250 MM

Output wire with Terminal: N.A

Packaging

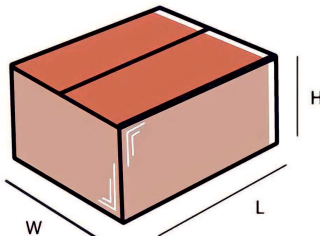

Master carton

OUTER DIMENSION		
L	W	H
270mm	195mm	185mm
Net Weight	Gross Weight	QUANTITY
7.5kg	8.0 kg	50 pc.

Installation Instructions:

- The driver should be installed in a dry, acid-free, oil free, fat-free environment.
- Do not exceed the declared Hot spot temperature(Tc max) under any circumstances.