



Features

- Support DALI-2+pushDIM+pushCCT control
- 2 channels of constant voltage output,at the tinting temperature, the output channel power is complementary, and the total output power remains unchanged
- Soft dimming and flicker-free at any brightness
- Dimming range 1~100%,support multiple lights dimming
- Standby power input<0.5W, meets the requirements of ErP certification
- High PF, high efficiency, low THD
- SELV and Class I design, suitable for use inside of the light
- Passed CE, DALI-2 certifications
- IP20 protection grade, indoor use
- Nominal life-time up to 100,000 h
- 5 years warranty

Interfaces

- DALI-2 (DALI-2 DT8)
- PUSH (pushDIM,corridorDIM)
- PUSH (pushCCT)

Functions

- PUSH dimming (pushDIM) and PUSH color temperature (pushCCT) with memory
- Support self-contained emergency application
- Protective features (short-circuit, overload,no-load protection)

Suitable for lights

- Suitable for CV strip lights, CV linear lights, floor lights, three-proof lights, etc

Typical applications

- LED indoor lighting
- LED office lighting
- LED commercial lighting



- DALI 2.0 Dt8 Constant Voltage LED Driver
- Output Wattage : 100W Max
- Flicker Free: O/P Ripple current < 10%
- Output voltage 24Vdc
- Linear CRCA Cabinet
- Suitable For Dry Locations
- Application:
 - Suitable for CV Strips, Linear Lights
 - Floor lights, three profile lights etc.

General Specifications

Rated Input Voltage	200-240VAC,50/60Hz
Operating Input Voltage Range	180-264VAC
Input Current	<0.65 (AC 200V)
Input Power	109.9W
Power Factor	PF>0.95 (230V AC & Full load),DF>0.98 (230V AC & Full load)
THD	≤10% (230V AC & Full Load)
Efficiency (Typical)	≥91%(230V AC & Full Load)
Driver Type	Constant Voltage
Output Current	4.2A
Output Voltage Range	24V
No Load Output Volatge	NA
Output Power	100W Max
Number of Output Channels	2 Channel
Class	Class I
Dimming Controller Type/Dimming Range	DALI 2.0,DT8,1%-100%
Ambient Operating Temperature Range	-20°C to 60°C
Max. Case Temperature	90°C
Input Surge Protection	L-N:2KV,L-FG/N-FG:2KV(Performance criterion:B)
Protections	Output Short Circuit : Yes Output Open Circuit : Auto Recovery (HICCUP Mode) Output Overload : Auto Recovery (HICCUP Mode)
Dali Standards	IEC62386-101, 102, 207,209
Withstand Voltage	I/P-O/P(LED):3750VAC,I/P-FG:1750VAC,O/P-FG:500VAC,I/P-DALI: 1500VAC,O/P-DALI: 1500VAC
Isolation resistance	I/P-FG:100MΩ/500Vdc/25°C/70% RH
Life	Nominal life-time up to 100,000 h
Approvals / Class	BIS,CE
Warranty	5 Years
Weight	0.372Kg

Note : Suitable for indoor application only

Electrical values

Efficiency vs load

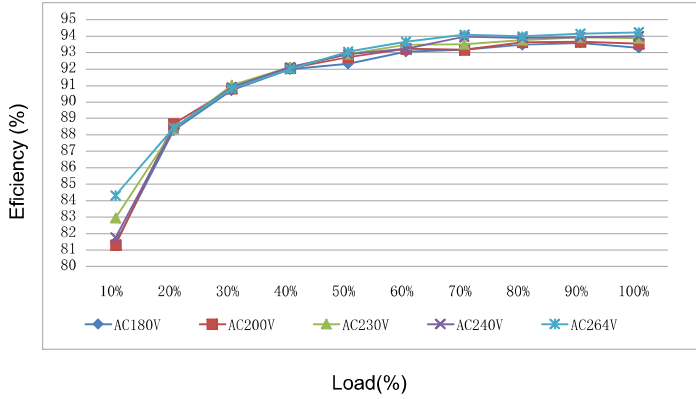

THD vs. Load

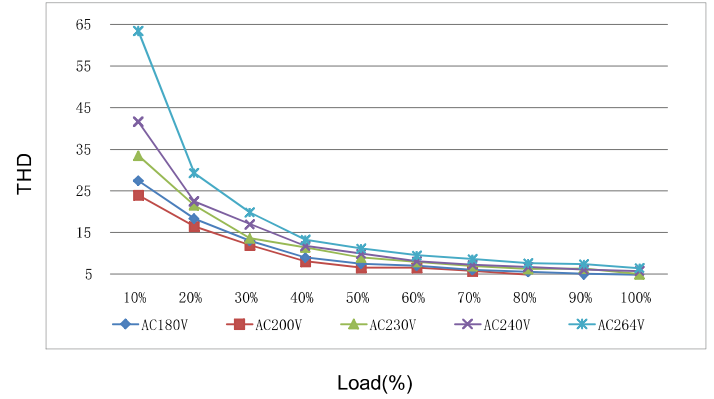

Power factor vs. Load

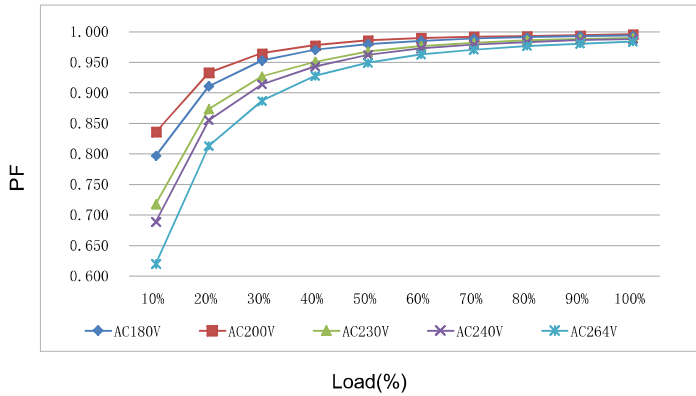

Life vs. Tc curve

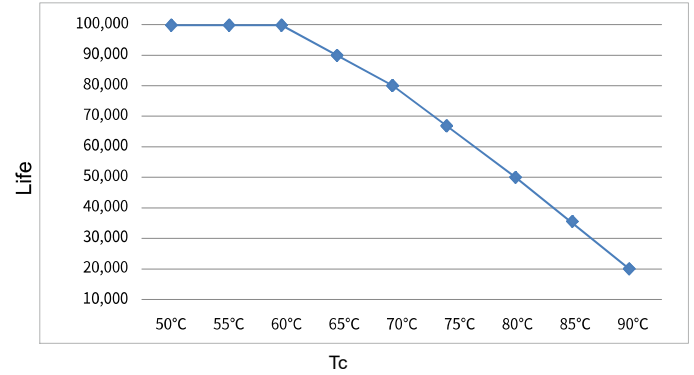

Fulham extends a limited warranty only to the original purchaser or to the first user for a period of **05 years @ Tc 80°C** from the date of manufacture when properly installed and operated under normal conditions of use. For complete terms and conditions, please reference the Fulham Product Catalog (www.fulham.com). Due to a program of continuous improvement, Fulham reserves the right to make modifications or variations in design or construction to the equipment described. © Fulham Company Limited, All Rights Reserved.

DALI dimming application

Wiring diagram

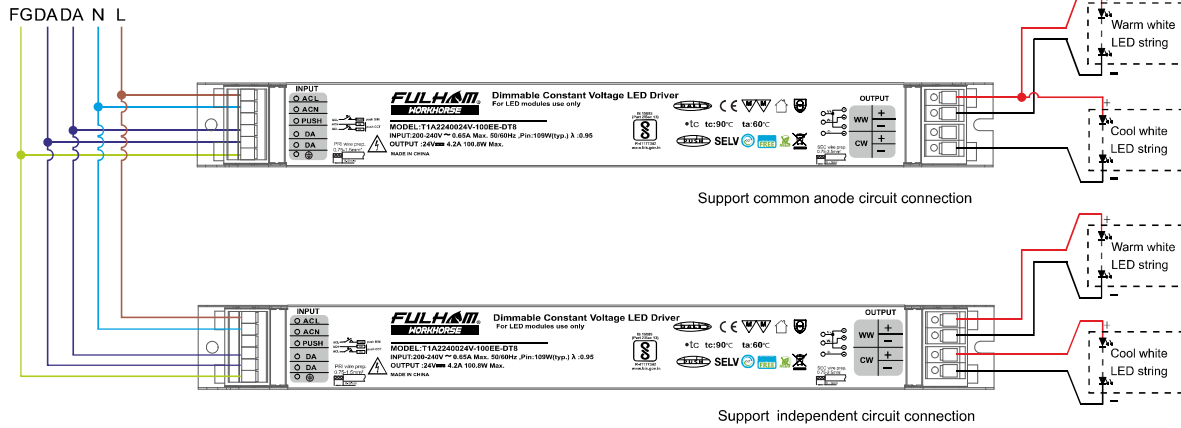

••• Max. x64

Note: The voltage deviation of warm white and cool white light strings should be less than 0.5V

Activating DALI control mode

-After installation according to the wiring diagram of DALI control application,the driver will automatically switch to the DALI control mode after receiving any DALI command.

Remarks:

- Standard DALI control line voltage range : 9.5V to 22.5V,Type 16V.
- The two DALI control lines polarity -reversible
- Max. 64 DALI drivers per DALI control line.
- The maximum distance length of the DALI CONTROL LINE IS 300MM AT 2X1.5MM²
- DALI bus can be wired together with any main voltage cables, but separate wiring is recommended.

Wiring distance vs cable size

Cable size	Distance
2×0.50mm ²	max.100m
2×0.75mm ²	max.150m
2×1.00mm ²	max.200m
≥2×1.50mm ²	max.300m

Dimming curve

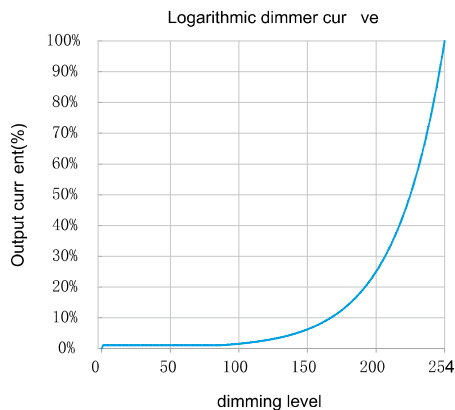

Remarks:

The dimming curve can be selected by DALI configuration. The default is logarithmic dimming curve.

Fulham extends a limited warranty only to the original purchaser or to the first user for a period of **05 years @ Tc 80°C** from the date of manufacture when properly installed and operated under normal conditions of use. For complete terms and conditions, please reference the Fulham Product Catalog (www.fulham.com). Due to a program of continuous improvement, Fulham reserves the right to make modifications or variations in design or construction to the equipment described. © Fulham Company Limited, All Rights Reserved.

pushDIM dimming application

Wiring diagram

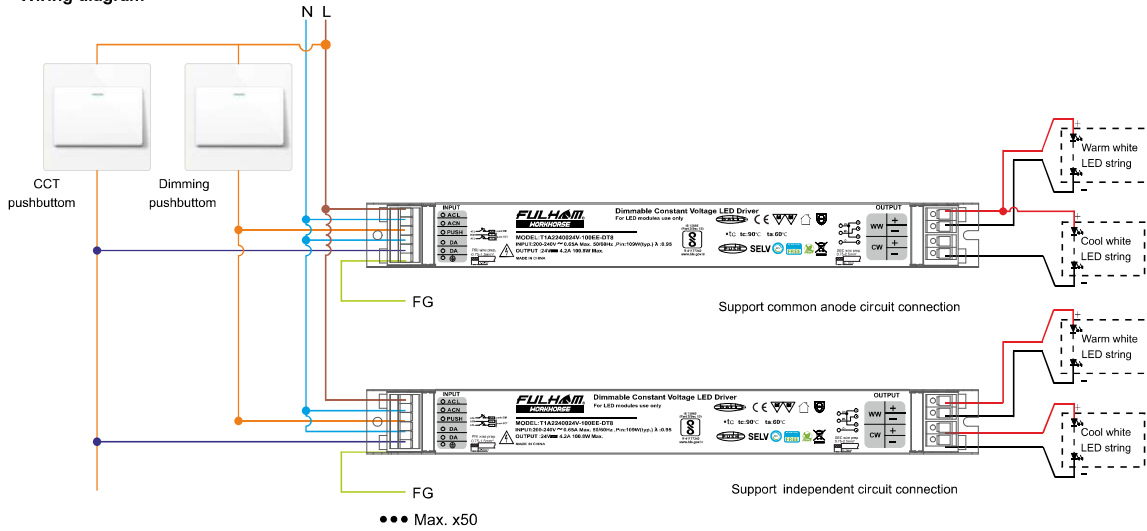

Note: The voltage deviation of warm white and cool white light strings should be less than 0.5V

Activating pushDIM,pushCCT control mode

- After installation according to the wiring diagram of pushDIM,pushCCT control application, short press the dimming pushbutton(pushDIM port) 5 times within 3 seconds, the driver will automatically switch to pushDIM,pushCCT control mode.
- After activating pushDIM, pushCCT control mode, CorridorDIM mode will be automatically closed.

Number of mounted drivers

- Up to 50pcs drivers can be mounted.

Dimming pushbutton operating instructions

- Turn on or turn off: short press dimming pushbutton for 0.2-1s.
- Stepless dimming : long press dimming pushbutton for 1-6s. Press again to switch dimming directions.

PUSH CCT switch operating instructions

- Switch CCT level: short press CCT pushbutton for 0.2-1s. 9 levels of preset CCT can be switched.
- Stepless CCT adjustment: long press CCT pushbutton for 1-6s, Press again to switch CCT adjustment directions.

Power on status:

- After power on,the light state will be the same as the last dimming level and the last CCT level.
- If the light is on before the power is turned off, after turning the power back on, the brightness will be the same as the last time, and the color temperature will be the same as the last time.
- If the light is off before the power is turned off, the light will be turned off after the power is turned back on. You need to press the dimming pushbutton for a short time to turn on the light. The brightness after lighting will be the same as the last time, and the color temperature will be the same as the last time.

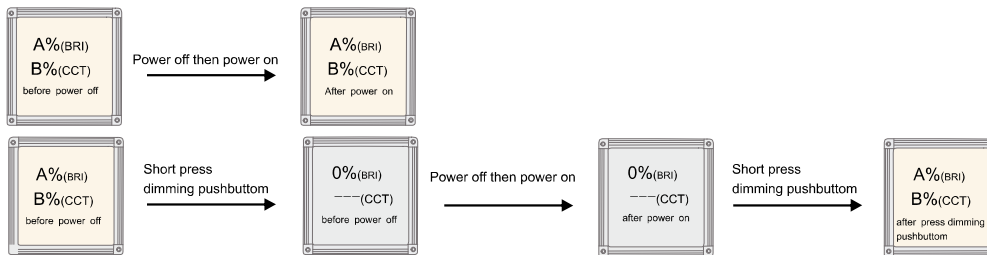

Multiple lights synchronize control operation

method 1:

- Step 1:long press the dimming pushbutton,confirm each light is on.
- Step 2:short press the dimming pushbutton,confirm each light is off.
- Step 3:long press the dimming pushbutton,confirm each light is from darkest to brightest and all the lights are synchronous.

method 2:

- Long press the dimming pushbutton for more than 15s, all drivers will output 100% brightness and the color temperature is natural white (middle of color temperature range).

Mechanical Data :

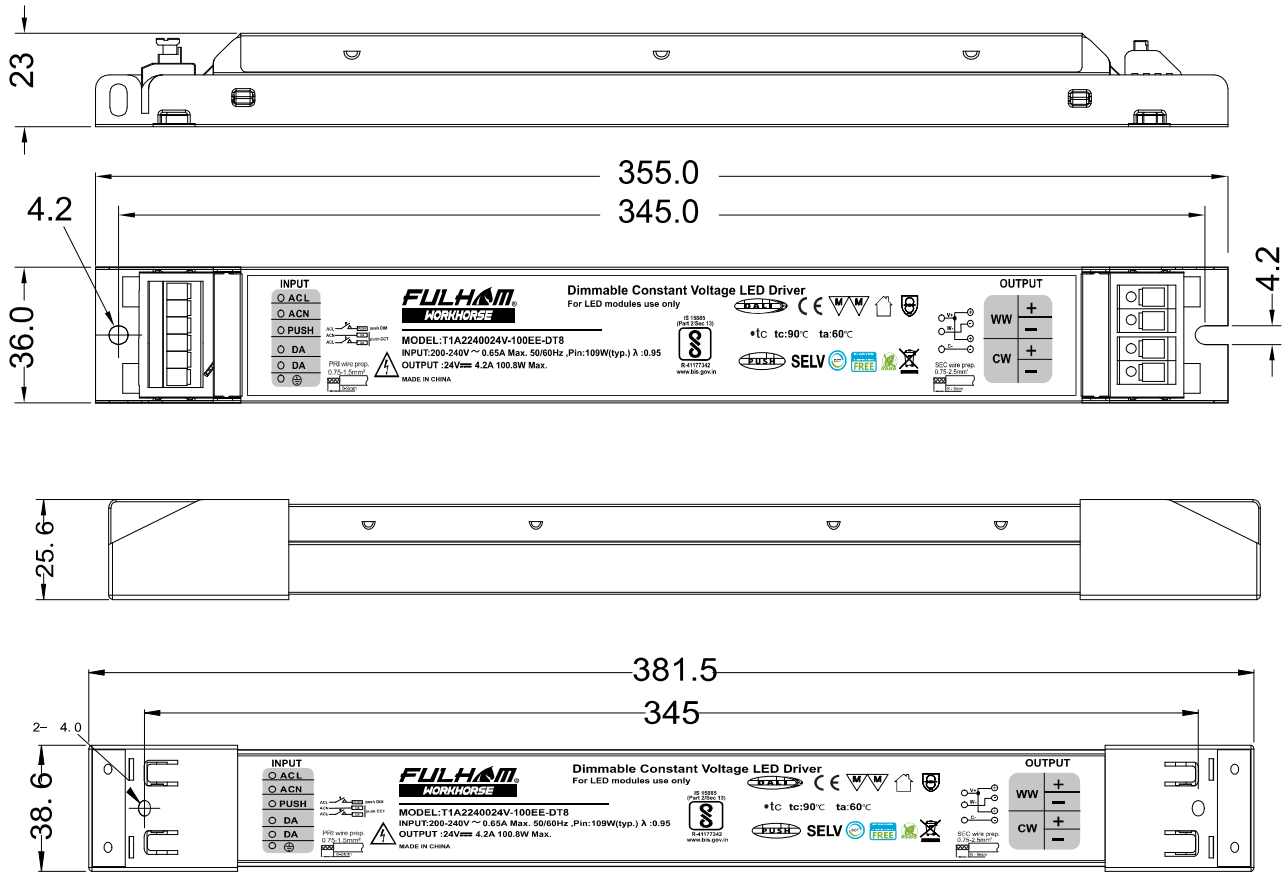

Note : All Dimensions are in mm.

Tolerance=±0.5mm

Packaging

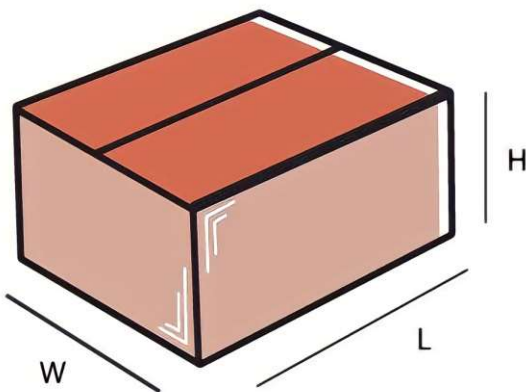

Master carton

OUTER DIMENSION		
L	W	H
395mm	355mm	160mm
Net Weight	Gross Weight	QUANTITY
8.93 kg	10.0 kg	24 pc.

Installation Instructions:

Connect Wires as per details given on the Driver Screen. Keep proper ventilation around the LED Driver and do not stack any object on it. Also a 10-15 cm clearance must be kept when the adjacent device is a heat source. Do not exceed the declared Hot spot temperature(Tc max) under any circumstances.

Fulham extends a limited warranty only to the original purchaser or to the first user for a period of **05 years @ Tc 80°C** from the date of manufacture when properly installed and operated under normal conditions of use. For complete terms and conditions, please reference the Fulham Product Catalog (www.fulham.com). Due to a program of continuous improvement, Fulham reserves the right to make modifications or variations in design or construction to the equipment described. © Fulham Company Limited, All Rights Reserved.